

The Daily Puzzle Post

Daily Printable Puzzle Packs for Senior Living Communities

Platinum

Three difficulty levels · Every resident, every day

The Platinum plan delivers a full range of puzzles for all community members. This includes three packs every morning – one relaxed pack for early memory care or just an easy puzzle day, one mixed level pack with something for everyone, and one challenger pack for your sharpest residents. All three PDFs arrive customised with your community's name and local weather. Each pack contains a full 12-puzzle lineup, including a daily Conversation Starter, Your Memories writing prompt, and Puzzle Partners – a rotating two-player game. The answer key is included at the end of each PDF. Best suited for communities that want a complete, daily activity programme without having to think about it.

DAILY CUSTOM PUZZLE PACK INCLUDES

15

pages total

12

puzzle pages

3

PDFs / day

FULL FIXED LINEUP – SAME 12 PUZZLES EVERY DAY

- **Daily Content + Sudoku** – quiz, weather, scores
- **Word Search**
- **Hitori**
- **Cryptogram**
- **Number Pyramid**
- **Naval Battle**
- **Bridges**
- **Binero**
- **Latin Square**
- **Conversation Starter + Your Memories**
- **Word Scramble**
- **Puzzle Partners** – rotating 2-player game
- **Answer Key (3 pages)** – appended to same PDF

DIFFICULTY PACKS INCLUDED

Mixed Level

For: Something for everyone in your community

A balanced mix of Easy, Medium, and Hard puzzles – the core daily pack.

Relaxed

For: Best for early-stage memory care or an easier day

All Easy – smaller grids, more hints, shorter words. Gentle engagement, no pressure.

Challenger

For: All puzzles at the most difficult level

Largest grids, no hints, hardest settings. For your sharpest community members.

Basic

1 PDF/day · Mixed Level
\$180/yr · \$19/mo

Gold

2 PDFs/day · + Relaxed
\$348/yr · \$39/mo

Platinum

3 PDFs/day · + Challenger
\$540/yr · \$59/mo
□ this sample

DIFFICULTY PACK

Mixed Level

For: Something for everyone in your community

Easy · Medium · Hard

*A balanced mix of Easy, Medium, and Hard puzzles
– the standard daily pack for your whole community.*

SUNRISE GARDENS VILLAGE

DAILY PUZZLE EDITION

Thursday, April 16, 2026

3-DAY FORECAST · TAMPA

THU

84°F

Sunny

FRI

87°F

Sunny

SAT

86°F

Partly Cloudy

LATEST SCORES

Baseball · MLB

Tampa Bay Rays 8 vs Chicago White Sox 3

Baseball · MLB

Atlanta Braves 6 vs Miami Marlins 3

DID YOU KNOW

A day on Venus is longer than a year on Venus. It rotates so slowly that it completes an orbit of the Sun before rotating once.

THE STORY BEHIND

The Post-it Note.

In 1968, a 3M scientist named Spencer Silver invented a glue just sticky enough to hold paper without leaving a mark. Nobody knew what to do with it for six years. Then a colleague used it to mark pages in his hymnal. Within a decade, every office in the world had them.

DAILY QUIZ · SPACE & EXPLORATION

- How long does light from the Sun take to reach Earth?
A) About 2 minutes B) About 8 minutes
C) About 20 minutes D) About 1 hour
- Which planet has the most moons in our solar system?
A) Jupiter B) Saturn
C) Uranus D) Neptune
- Who was the first human being to travel in space?
A) Buzz Aldrin B) Alan Shepard
C) Yuri Gagarin D) John Glenn

SUDOKU

Fill each row, column & 3×3 box with 1–9.

Puzzle 1 — Easy

1		4	3	5	2	7		8
	8		6		4	3		2
6	3	2	8	1			9	
	5	3		7	8	4		
	4	8	9	2	6	1	3	
		1	5	4		8	7	
	1			3	5	6	4	7
3		6	4		9		5	
4		5	7	6	1	9		3

Puzzle 2 — Medium

9		6		4		3	2	8
	7	4		2	8			6
8	1	2					4	
	6			1		5	3	
1	2	7	8		5	4	6	9
	3	9		6			7	
	4					2	5	7
2			4	7		1	8	
7	8	3		5		6		4

MAPPING THE UNIVERSE

Search for words horizontally, vertically, and diagonally.

COMET
GRAVITY
PULSAR

COSMOS
HORIZON
SATURN

ECLIPSE
NEBULA
SOLSTICE

EQUINOX
NEUTRON
TELESCOPE

GALAXY
ORBITAL
ZENITH

H	M	M	X	N	E	J	D	E	P	A	D	C	R	W
D	T	S	E	K	K	Q	O	E	U	M	A	H	F	R
H	X	E	T	C	W	P	U	C	E	V	O	I	R	U
O	X	Q	L	L	L	J	E	I	O	C	U	K	X	D
R	Z	N	N	E	Y	I	K	S	N	S	F	B	J	Y
I	J	E	E	C	S	Q	P	E	D	O	M	L	C	Z
Z	X	B	U	O	L	C	K	S	P	H	X	O	O	K
O	J	U	T	M	R	Z	O	S	E	A	N	R	S	K
N	W	L	R	E	N	R	O	P	S	G	B	O	G	Z
N	L	A	O	T	X	L	U	A	E	I	E	H	A	E
R	M	V	N	F	S	L	T	V	T	C	C	P	L	N
C	O	L	G	T	S	U	G	A	Z	O	E	E	A	I
G	N	P	I	A	R	V	L	Z	P	K	M	G	X	T
B	W	C	R	N	C	U	R	L	X	Q	C	Q	Y	H
N	E	G	R	A	V	I	T	Y	D	Z	G	W	Y	Z

Shade cells so no number appears twice in any row or column. Shaded cells may not touch horizontally or vertically, but can touch diagonally. All unshaded cells must stay connected.

Puzzle 1 — Easy

3	5	1	2	1
2	3	2	1	5
2	3	1	5	3
5	1	3	2	2
1	2	5	3	5

Puzzle 2 — Medium

5	3	3	2	6	4
6	2	1	5	2	3
4	5	5	6	3	1
2	6	5	4	1	2
2	3	4	1	5	5
1	4	6	6	2	5

Puzzle 3 — Medium

4	5	3	2	6	3
4	6	2	4	3	1
2	4	3	1	5	1
6	3	4	5	2	2
1	4	6	3	4	5
3	1	5	3	2	4

Puzzle 4 — Hard

7	6	5	8	4	1	5	2
8	1	1	2	3	7	5	6
7	3	7	6	5	8	1	4
6	5	8	4	1	2	7	8
5	8	4	7	2	3	6	7
3	7	6	5	4	4	2	1
1	2	5	7	6	5	4	8
4	1	2	3	7	1	8	5

All three puzzles share the same key. Decode each letter using the cipher below.

CIPHER KEY — encoded letter = plain letter

A=I	B=H	C=A	D=V	E=K	F=U	G=W	H=Q	I=Z	J=T	K=S	L=N	M=J
N=G	O=B	P=L	Q=P	R=E	S=X	T=M	U=R	V=O	W=C	X=D	Y=F	Z=Y

ON EXPLORATION

J B R R C U J B A K J B R W U C X P R V Y

B F T C L A J Z O F J V L R W C L L V J

P A D R A L C W U C X P R Y V U R D R U

— Konstantin Tsiolkovsky

ON WONDER

K V T R G B R U R K V T R J B A L N

A L W U R X A O P R A K G C A J A L N J V O R

E L V G L

— Carl Sagan

ON THE MOON

J B C J A K V L R K T C P P K J R Q Y V U

T C L V L R N A C L J P R C Q Y V U

T C L E A L X

— Neil Armstrong

Each brick equals the sum of the two bricks directly below it.
 Fill every empty brick. Work upward by adding, or downward by subtracting.

Pyramid 1 — Easy

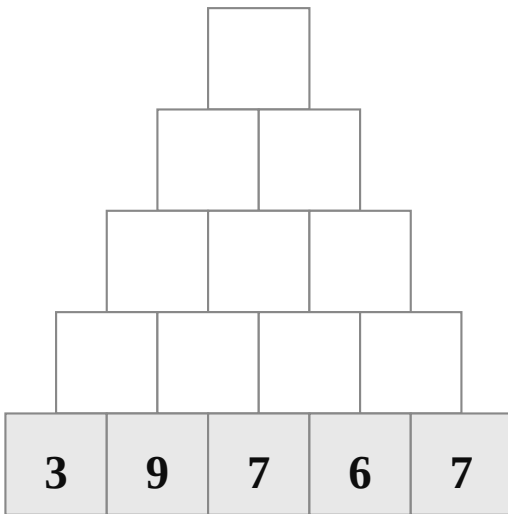

Pyramid 2 — Medium

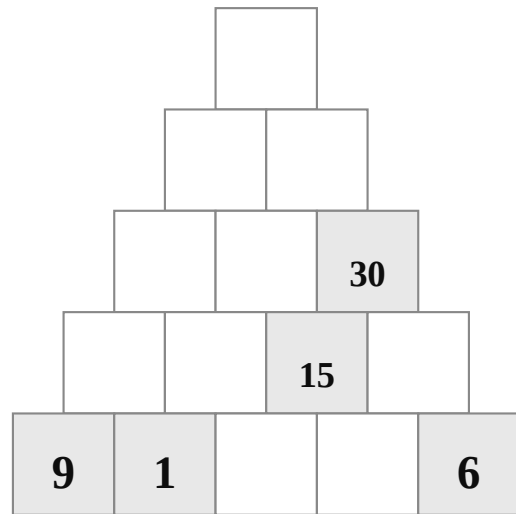

Pyramid 3 — Medium

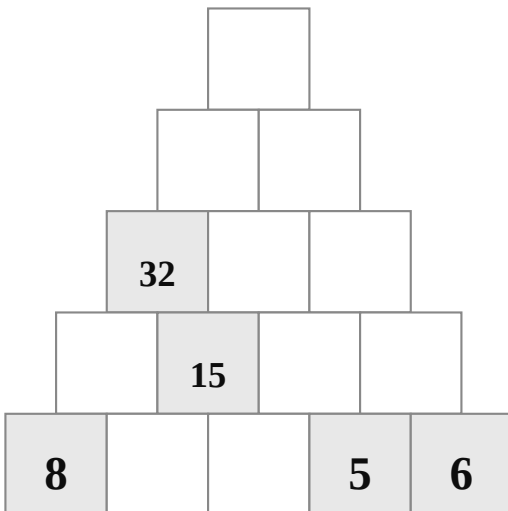

Pyramid 4 — Hard

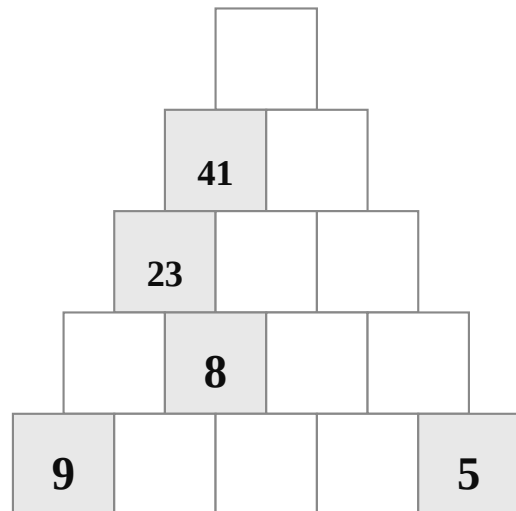

Use the row and column numbers to locate every ship. Ships cannot touch each other, not even diagonally.

Numbers show ship cells per row and column. Mark empty cells to narrow down where ships can fit.

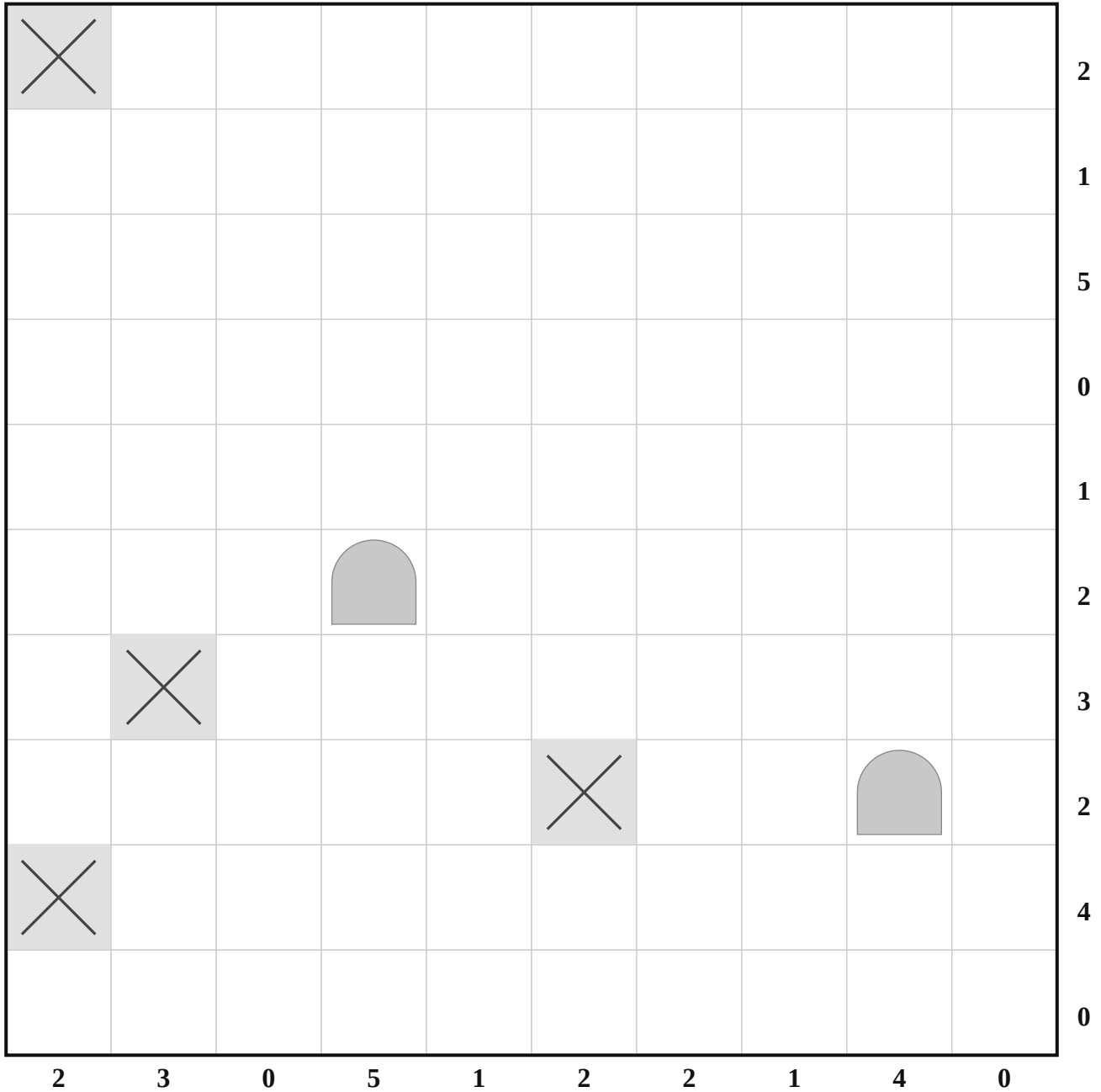

Hints:  = Ship segment  = Water

FLEET

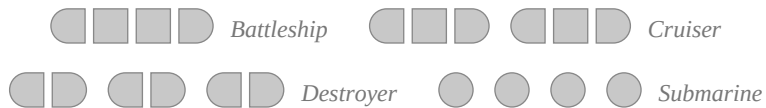

Connect every island with horizontal or vertical bridges — no diagonals. Each number tells you exactly how many bridges meet that island. Bridges cannot cross each other. Up to two bridges can run between any two islands.

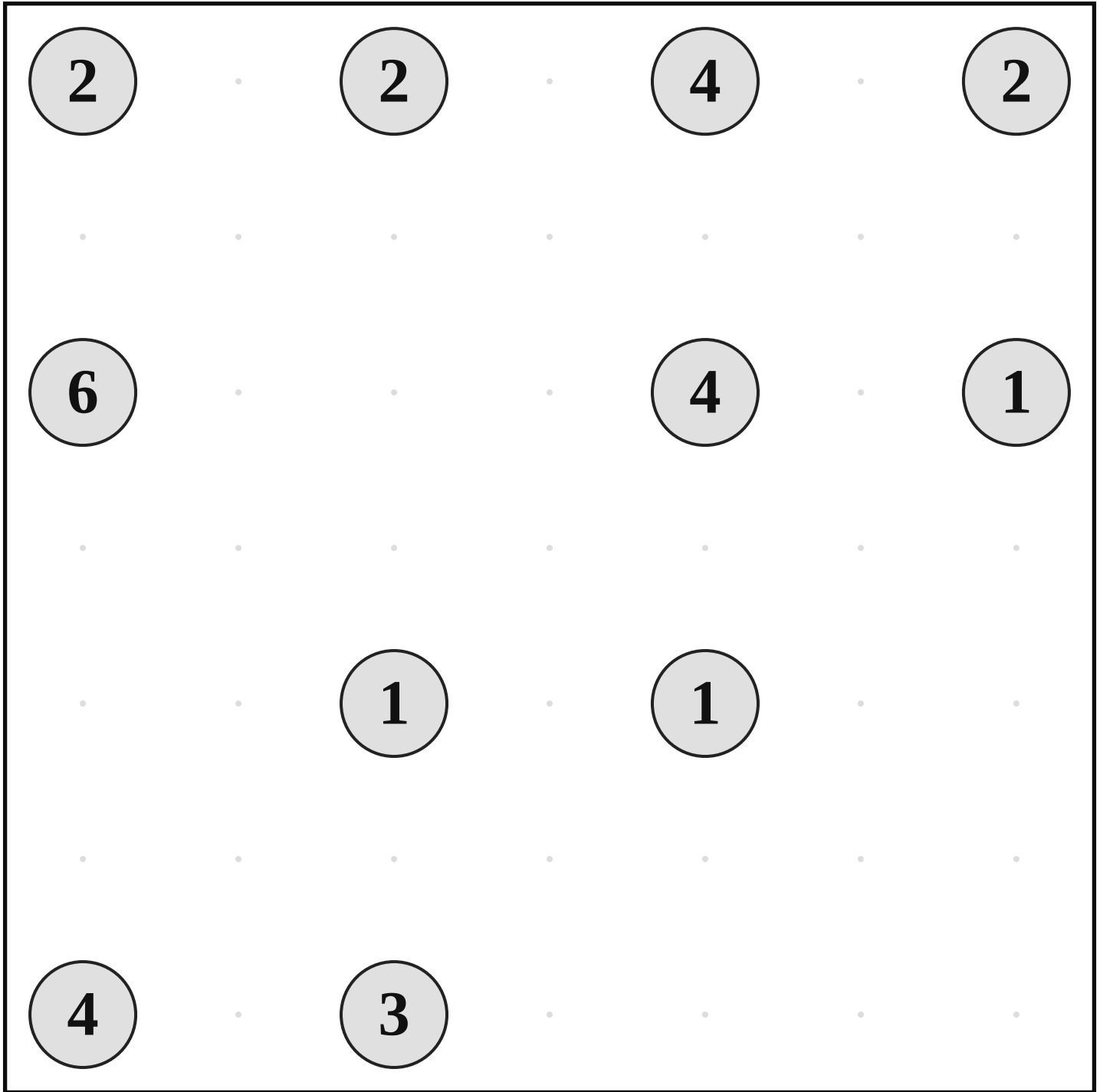

Fill each cell with 0 or 1. Every row and column must contain exactly ten 0s and ten 1s.

Never place 3 of the same digit in a row, whether in a row or column. No two rows or columns can be the same.

			0	0						0	1	0	1	1	0	0	1	1	
	0	0		0	1	1			0					1	0	1	0		
	1	1			0			0	1		0				1	1	0	1	0
	0	0		1			1	0	1		1	1	0			0	1	1	
		1	0	0	1	1	0	1	0		0	0		0	1		0	0	1
1			0		1		0		0	1			0	0	1			0	1
1	0	0		1	0	0		0	1	0		0	1		0	1		1	
0	1		0			1	0		1	0	1			1		1		1	0
0	1			1		1		1	0				0	0	1			0	
1	0		0	0			1	1				0	1			1		0	1
	0	0		1		1	0	0	1	1						0	1		
		1	0		1	1	0	1	0		0	1		0	1	0	1		
		0			0	0	1	1	0	0	1				1	1			
0			0		1		1		1	0		1		1			1	0	1
0	1			0	1	1						0				0	1	0	1
1	0			1	0	0		0			1	1	0						0
	0		1		0			1		1	0	1	0					0	1
0	1	0	1							1	0	0		1	0			0	
0	1	1									1	1	0	1	0	0	1		0
			1	1	0	0	1		1	1		1	0	0				1	

Fill every row and column with each number exactly once — no repeats in any row or column.

Puzzle 1 — Easy

3	1		
	2	3	1
	4	1	3
1	3	4	2

Puzzle 2 — Medium

4	1		2	3	6
				6	
	3	2			4
					3
	2	4		5	
			1	4	2

Puzzle 3 — Medium

	6			3	
3	2		1		6
	5	2			
	3	1	6	5	2
	4	6	2		

Puzzle 4 — Hard

		7		4	8		
7			4		1	8	
	6						
5	2						
		2	1	3			
		1				4	3
6		5					8
		4	8	1		7	2

MAPPING THE UNIVERSE

Rearrange the letters to find the hidden word. Use the hint if you need a little help.

SCRAMBLED	HINT	ANSWER
1. RRETCA	<i>A bowl-shaped hollow on the surface of the Moon</i>	_____
2. CKEOTR	<i>A vehicle powered by burning fuel to escape Earth's gravity</i>	_____
3. OTMREE	<i>A streak of light caused by space rock burning in our atmosphere</i>	_____
4. UVUCMA	<i>A space containing no matter — like outer space itself</i>	_____
5. USCELPA	<i>A small sealed compartment in which astronauts travel</i>	_____
6. EIADROTS	<i>A rocky object orbiting the sun smaller than a planet</i>	_____
7. AELTIESLT	<i>An object that orbits a planet — natural or man-made</i>	_____
8. KECLBLAHO	<i>A region of space where gravity is so strong nothing escapes</i>	_____
9. ALCANDUPH	<i>The platform from which a rocket lifts off</i>	_____
10. OBTIR	<i>The curved path one object follows around another in space</i>	_____
11. NURLA	<i>Relating to the Moon</i>	_____
12. LORSA	<i>Relating to the Sun</i>	_____
13. RAFLE	<i>A sudden burst of energy released from the surface of the Sun</i>	_____

DOTS & BOXES — A TWO-PLAYER GAME

Player 1: X Player 2: O

*Take turns drawing one line between two neighbouring dots (H or V).
Complete the 4th side of a box → write your initial inside and take another turn. Most boxes wins.*

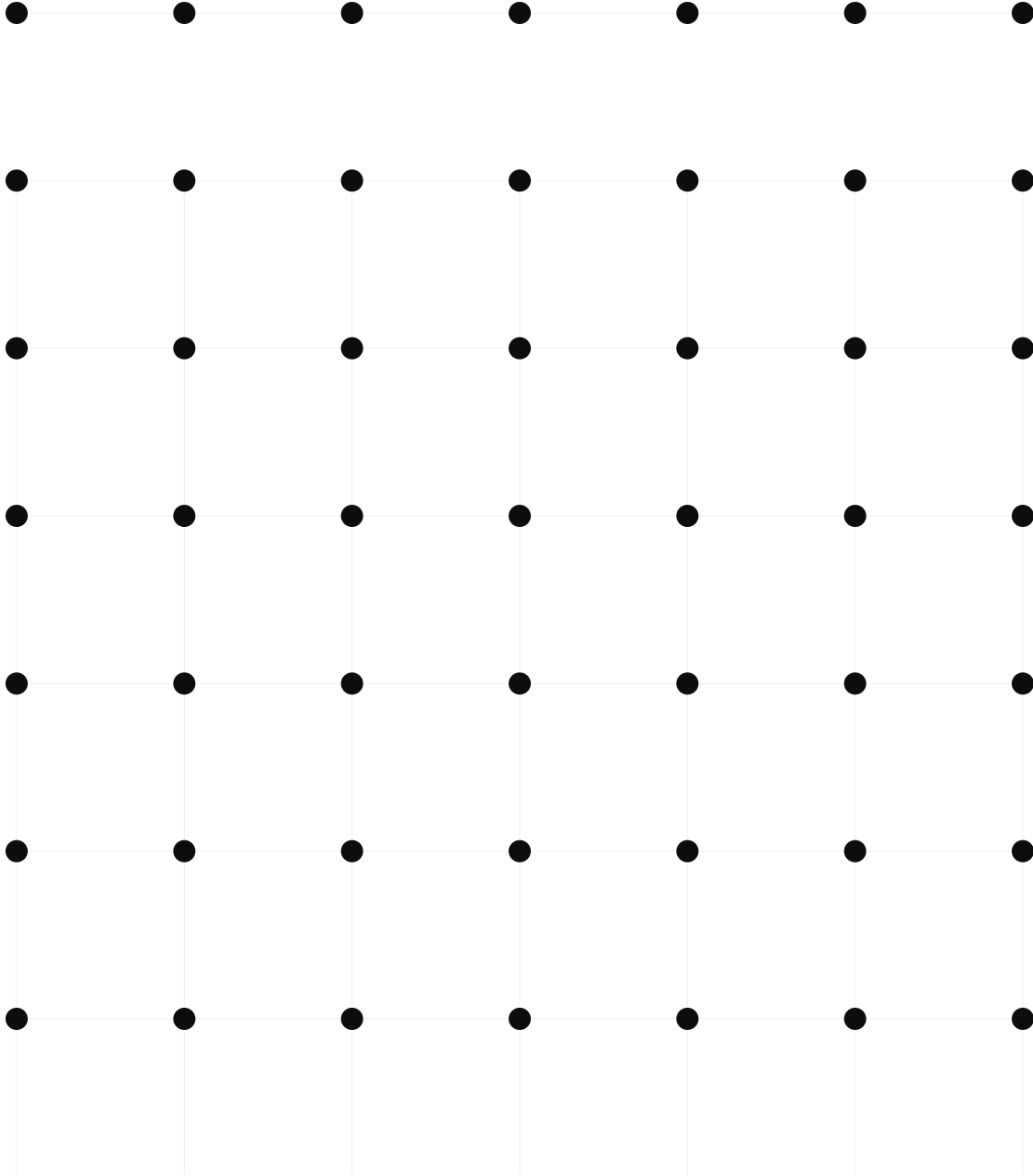

X BOXES _____	O BOXES _____
-------------------------	-------------------------

SUNRISE GARDENS VILLAGE

Answer Key · Thursday, April 16, 2026

ANSWERS — DAILY QUIZ · SPACE & EXPLORATION

1. How long does light from the Sun take to reach Earth?

- A) About 2 minutes
- B) About 8 minutes ✓**
- C) About 20 minutes
- D) About 1 hour

2. Which planet has the most moons in our solar system?

- A) Jupiter
- B) Saturn ✓**
- C) Uranus
- D) Neptune

3. Who was the first human being to travel in space?

- A) Buzz Aldrin
- B) Alan Shepard
- C) Yuri Gagarin ✓**
- D) John Glenn

SUNRISE GARDENS VILLAGE

Answer Key · Thursday, April 16, 2026

ANSWERS — SUDOKU

Easy

Medium

1	9	4	3	5	2	7	6	8
5	8	7	6	9	4	3	1	2
6	3	2	8	1	7	5	9	4
9	5	3	1	7	8	4	2	6
7	4	8	9	2	6	1	3	5
2	6	1	5	4	3	8	7	9
8	1	9	2	3	5	6	4	7
3	7	6	4	8	9	2	5	1
4	2	5	7	6	1	9	8	3

9	5	6	7	4	1	3	2	8
3	7	4	5	2	8	9	1	6
8	1	2	6	9	3	7	4	5
4	6	8	9	1	7	5	3	2
1	2	7	8	3	5	4	6	9
5	3	9	2	6	4	8	7	1
6	4	1	3	8	9	2	5	7
2	9	5	4	7	6	1	8	3
7	8	3	1	5	2	6	9	4

SUNRISE GARDENS VILLAGE

Answer Key · Thursday, April 16, 2026

ANSWERS — WORD SEARCH — MAPPING THE UNIVERSE

A	I	E	Y	N	C	T	X	E	H	N	R	P	E	Y
J	V	Q	M	O	S	F	E	O	Z	O	N	X	U	O
L	A	U	S	P	J	Y	G	L	N	C	O	M	E	T
R	R	M	W	P	N	M	U	Y	E	I	T	Z	H	I
S	O	W	O	R	B	I	T	A	L	S	U	A	E	N
S	O	K	G	R	A	S	L	U	P	Y	C	Q	P	V
P	D	I	E	C	L	I	P	S	E	O	W	O	E	M
N	O	R	T	U	E	N	R	X	H	O	K	U	P	R
T	O	V	N	M	M	C	H	O	R	I	Z	O	N	E
O	R	T	L	A	L	U	B	E	N	S	L	U	M	G
R	J	O	J	C	N	X	N	R	U	T	A	S	C	H
K	P	F	T	Y	T	I	V	A	R	G	F	L	E	O
P	J	J	Y	Y	H	G	A	L	A	X	Y	N	E	L
I	H	E	C	I	T	S	L	O	S	M	M	X	N	J
D	E	P	A	D	C	R	W	H	T	I	N	E	Z	D

■ = word letter (grey = filler)

SUNRISE GARDENS VILLAGE

Answer Key · Thursday, April 16, 2026

ANSWERS — HITORI

Puzzle 1 — Solution

3	5		2	1
	3	2	1	5
2		1	5	3
5	1	3		2
1	2	5	3	

Puzzle 2 — Solution

5		3	2	6	4
6	2	1	5		3
4	5		6	3	1
	6	5	4	1	2
2	3	4	1	5	
1	4	6		2	5

Puzzle 3 — Solution

4	5		2	6	3
	6	2	4	3	1
2	4	3	1	5	
6	3	4	5		2
1		6	3	4	5
3	1	5		2	4

Puzzle 4 — Solution

7	6	5	8	4	1		2
8		1	2	3	7	5	6
	3	7	6	5	8	1	4
6	5	8	4	1	2	7	
5	8	4		2	3	6	7
3	7	6	5		4	2	1
1	2		7	6	5	4	8
4	1	2	3	7		8	5

SUNRISE GARDENS VILLAGE

Answer Key · Thursday, April 16, 2026

ANSWERS — CRYPTOGRAM

ON EXPLORATION

The Earth Is The Cradle Of Humanity But One Cannot Live In A Cradle Forever

— Konstantin Tsiolkovsky

ON WONDER

Somewhere Something Incredible Is Waiting To Be Known

— Carl Sagan

ON THE MOON

That Is One Small Step For Man One Giant Leap For Mankind

— Neil Armstrong

SUNRISE GARDENS VILLAGE

Answer Key · Thursday, April 16, 2026

ANSWERS — NAVAL BATTLE

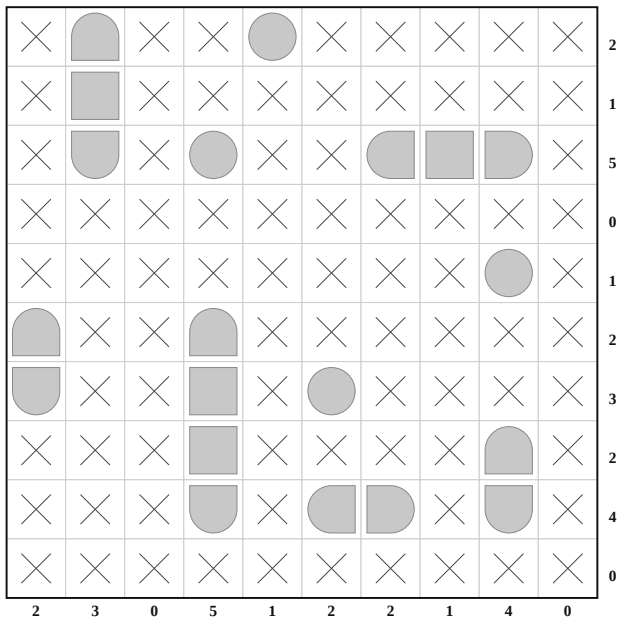

FLEET



SUNRISE GARDENS VILLAGE

Answer Key · Thursday, April 16, 2026

ANSWERS — NUMBER PYRAMID

Pyramid 1 — Solution

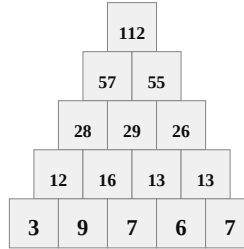

Pyramid 2 — Solution

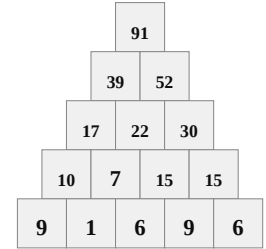

Pyramid 3 — Solution

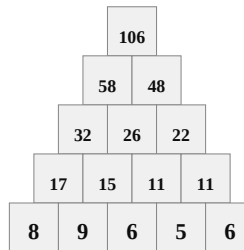

Pyramid 4 — Solution

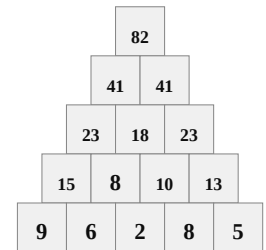

SUNRISE GARDENS VILLAGE

Answer Key · Thursday, April 16, 2026

ANSWERS — BRIDGES

Note: This puzzle may have more than one valid solution. Any arrangement satisfying all island counts with all islands connected is correct.

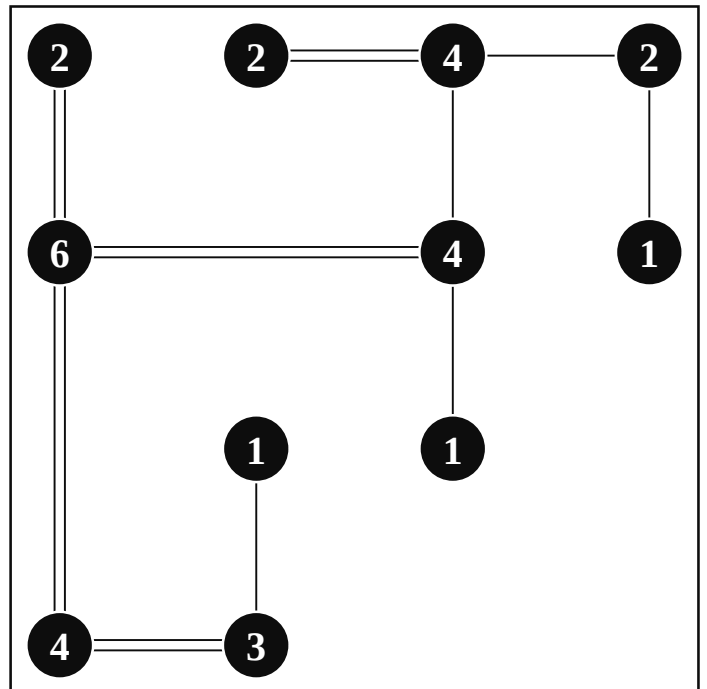

SUNRISE GARDENS VILLAGE

Answer Key · Thursday, April 16, 2026

ANSWERS — BINERO

0	1	1	0	0	1	0	1	0	1	0	1	0	1	1	0	0	1	1	0
1	0	0	1	0	1	1	0	1	0	0	1	1	0	1	0	1	0	0	1
0	1	1	0	1	0	0	1	0	1	1	0	0	1	0	1	1	0	1	0
1	0	0	1	1	0	0	1	0	1	0	1	1	0	1	0	0	1	1	0
0	1	1	0	0	1	1	0	1	0	1	0	0	1	0	1	1	0	0	1
1	0	1	0	0	1	1	0	1	0	1	0	1	0	0	1	0	1	0	1
1	0	0	1	1	0	0	1	0	1	0	1	0	1	1	0	1	0	1	0
0	1	1	0	0	1	1	0	0	1	0	1	0	1	1	0	1	0	1	0
0	1	0	1	1	0	1	0	1	0	1	0	1	0	0	1	0	1	0	1
1	0	1	0	0	1	0	1	1	0	0	1	0	1	0	1	1	0	0	1
1	0	0	1	1	0	1	0	0	1	1	0	0	1	1	0	0	1	1	0
0	1	1	0	0	1	1	0	1	0	1	0	1	0	0	1	0	1	0	1
1	0	0	1	1	0	0	1	1	0	0	1	0	1	0	1	1	0	1	0
0	1	1	0	0	1	1	0	1	0	1	0	1	1	0	1	0	1	0	1
1	0	1	0	1	0	0	1	0	1	0	1	1	0	1	0	1	0	1	0
1	0	0	1	1	0	1	0	0	1	1	0	0	1	1	0	0	1	1	0
0	1	1	0	1	0	1	0	1	0	1	0	0	1	1	0	1	0	0	1
0	1	1	0	1	0	1	0	1	0	1	0	0	1	1	0	1	0	0	1
0	1	1	0	1	0	1	0	1	0	0	1	1	0	1	0	0	1	1	0
1	0	0	1	1	0	0	1	0	1	1	0	1	0	0	1	1	0	1	0

SUNRISE GARDENS VILLAGE

Answer Key · Thursday, April 16, 2026

ANSWERS — LATIN SQUARE

Puzzle 1 — Solution

3	1	2	4
4	2	3	1
2	4	1	3
1	3	4	2

Puzzle 2 — Solution

4	1	5	2	3	6
2	4	1	3	6	5
6	3	2	5	1	4
1	5	6	4	2	3
3	2	4	6	5	1
5	6	3	1	4	2

Puzzle 3 — Solution

2	6	4	5	3	1
3	2	5	1	4	6
6	1	3	4	2	5
1	5	2	3	6	4
4	3	1	6	5	2
5	4	6	2	1	3

Puzzle 4 — Solution

2	1	7	3	4	8	5	6
7	3	6	4	2	1	8	5
1	6	3	5	8	7	2	4
5	2	8	7	6	4	3	1
4	8	2	1	3	5	6	7
8	7	1	6	5	2	4	3
6	4	5	2	7	3	1	8
3	5	4	8	1	6	7	2

SUNRISE GARDENS VILLAGE

Answer Key · Thursday, April 16, 2026

ANSWERS — WORD SCRAMBLE

SCRAMBLED	ANSWER
1. RRETCA	CRATER
2. CKEOTR	ROCKET
3. OTMREE	METEOR
4. UVUCMA	VACUUM
5. USCELPA	CAPSULE
6. EIADROTS	ASTEROID
7. AELTIESLT	SATELLITE
8. KECLBLAHO	BLACKHOLE
9. ALCANDUPH	LAUNCHPAD
10. OBTIR	ORBIT
11. NURLA	LUNAR
12. LORSA	SOLAR
13. RAFLE	FLARE

DIFFICULTY PACK

Relaxed

For: Best for early-stage memory care or an easier day

All Easy

Smaller grids, more hints, shorter words. Gentle engagement for memory care and those who prefer to take it slow.

SUNRISE GARDENS VILLAGE

DAILY PUZZLE EDITION
Thursday, April 16, 2026

3-DAY FORECAST · TAMPA

THU	FRI	SAT
84°F	87°F	86°F
Sunny	Sunny	Partly Cloudy

LATEST SCORES

Baseball · MLB
Tampa Bay Rays 8 vs Chicago White Sox 3
Baseball · MLB
Atlanta Braves 6 vs Miami Marlins 3

DID YOU KNOW

A day on Venus is longer than a year on Venus. It rotates so slowly that it completes an orbit of the Sun before rotating once.

THE STORY BEHIND

The Post-it Note.

In 1968, a 3M scientist named Spencer Silver invented a glue just sticky enough to hold paper without leaving a mark. Nobody knew what to do with it for six years. Then a colleague used it to mark pages in his hymnal. Within a decade, every office in the world had them.

DAILY QUIZ · SPACE & EXPLORATION

- How long does light from the Sun take to reach Earth?
A) About 2 minutes B) About 8 minutes
C) About 20 minutes D) About 1 hour
- Which planet has the most moons in our solar system?
A) Jupiter B) Saturn
C) Uranus D) Neptune
- Who was the first human being to travel in space?
A) Buzz Aldrin B) Alan Shepard
C) Yuri Gagarin D) John Glenn

SUDOKU

Fill each row, column & 3×3 box with 1–9.
Puzzle 1 — Easy

1		4	3	5	2	7		8
	8		6		4	3		2
6	3	2	8	1			9	
	5	3		7	8	4		
	4	8	9	2	6	1	3	
		1	5	4		8	7	
	1			3	5	6	4	7
3		6	4		9		5	
4		5	7	6	1	9		3

Puzzle 2 — Easy

9		6		4		3	2	8
	7	4		2	8		1	6
8	1	2		9			4	
	6			1		5	3	2
1	2	7	8		5	4	6	9
5	3	9		6			7	
	4			8		2	5	7
2	9		4	7		1	8	
7	8	3		5		6		4

MAPPING THE UNIVERSE

Search for words horizontally and vertically, forwards only.

COMET
NEUTRON

COSMOS
ORBITAL

ECLIPSE
PULSAR

GALAXY
SOLSTICE

NEBULA
TELESCOPE

A	K	Z	G	J	C	T	T	F	B	U	T	M	S	A
Q	R	O	M	N	O	E	S	B	Y	N	P	Y	J	K
O	G	R	V	E	M	L	Q	I	V	D	U	P	D	X
Q	G	B	P	S	E	E	S	M	N	E	B	U	L	A
W	X	I	U	F	T	S	Q	X	K	U	W	F	F	A
Y	C	T	L	F	S	C	N	E	U	T	R	O	N	L
S	V	A	S	V	X	O	X	F	A	S	K	F	E	Z
G	A	L	A	X	Y	P	K	S	W	J	T	B	C	J
C	Y	D	R	L	L	E	C	O	A	F	Q	U	L	C
W	G	U	L	G	G	N	O	L	A	F	N	B	I	W
E	J	S	D	L	Z	T	S	S	L	V	E	G	P	I
F	U	K	H	F	C	G	M	T	K	O	T	B	S	W
F	N	V	H	L	E	R	O	I	I	T	N	H	E	U
F	O	J	H	S	Z	J	S	C	S	O	K	G	V	B
A	G	E	L	T	L	O	R	E	Q	T	G	U	Y	F

Shade cells so no number appears twice in any row or column. Shaded cells may not touch horizontally or vertically, but can touch diagonally. All unshaded cells must stay connected.

Puzzle 1

3	4	1	4
4	4	3	1
4	1	1	3
1	3	4	3

Puzzle 2

4	3	1	3
3	3	4	1
2	1	4	4
2	4	2	3

Puzzle 3

2	2	1	4
3	1	3	2
4	4	2	3
4	2	3	3

Puzzle 4

2	2	4	3
1	2	2	4
3	4	2	2
3	3	1	2

All three puzzles share the same key. Decode each letter using the cipher below.

CIPHER KEY — encoded letter = plain letter

A=I	B=H	C=A	D=V	E=K	F=U	G=W	H=Q	I=Z	J=T	K=S	L=N	M=J
N=G	O=B	P=L	Q=P	R=E	S=X	T=M	U=R	V=O	W=C	X=D	Y=F	Z=Y

ON EXPLORATION

J B R R C U J B A K J B R W U C X P R V Y

B F T C L A J Z O F J V L R W C L L V J

P A D R A L C W U C X P R Y V U R D R U

— Konstantin Tsiolkovsky

ON WONDER

K V T R G B R U R K V T R J B A L N

A L W U R X A O P R A K G C A J A L N J V O R

E L V G L

— Carl Sagan

ON THE MOON

J B C J A K V L R K T C P P K J R Q Y V U

T C L V L R N A C L J P R C Q Y V U

T C L E A L X

— Neil Armstrong

Each brick equals the sum of the two bricks directly below it.
Fill every empty brick. Work upward by adding, or downward by subtracting.

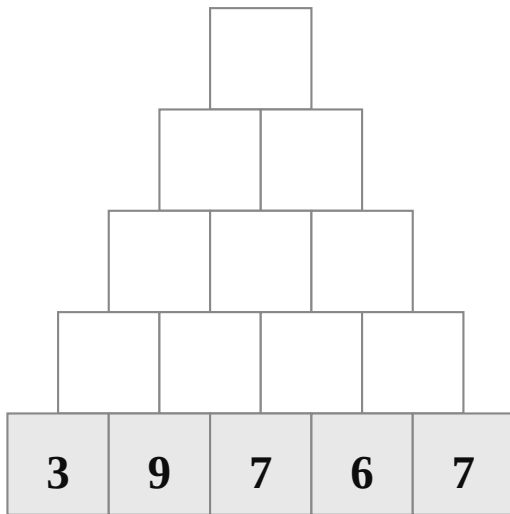
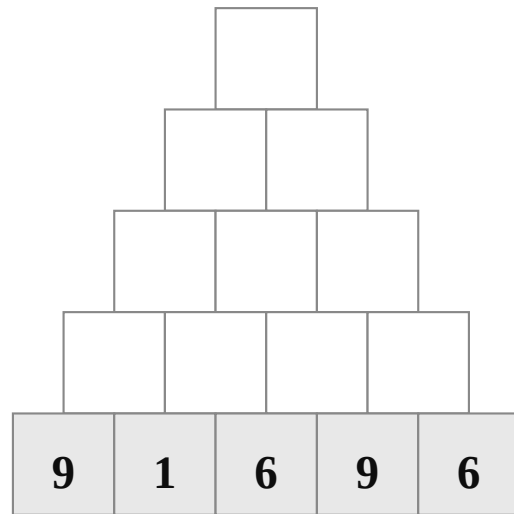
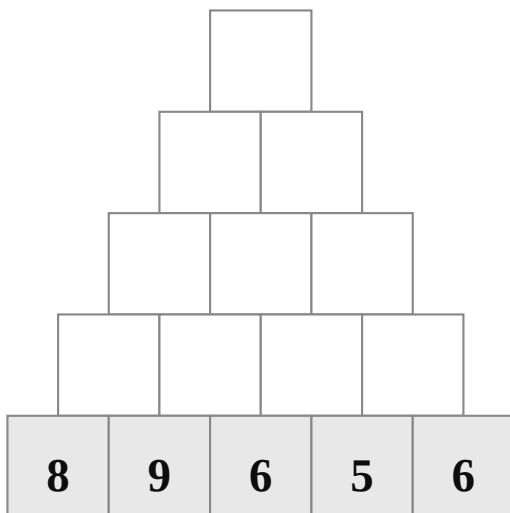
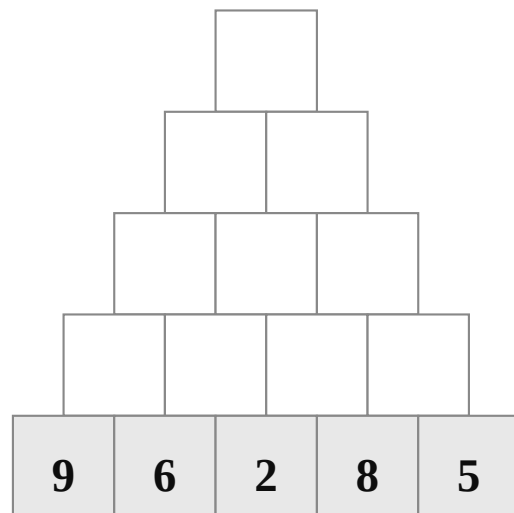
Pyramid 1**Pyramid 2****Pyramid 3****Pyramid 4**

Use the row and column numbers to locate every ship. Ships cannot touch each other, not even diagonally.

Numbers show ship cells per row and column. Mark empty cells to narrow down where ships can fit.

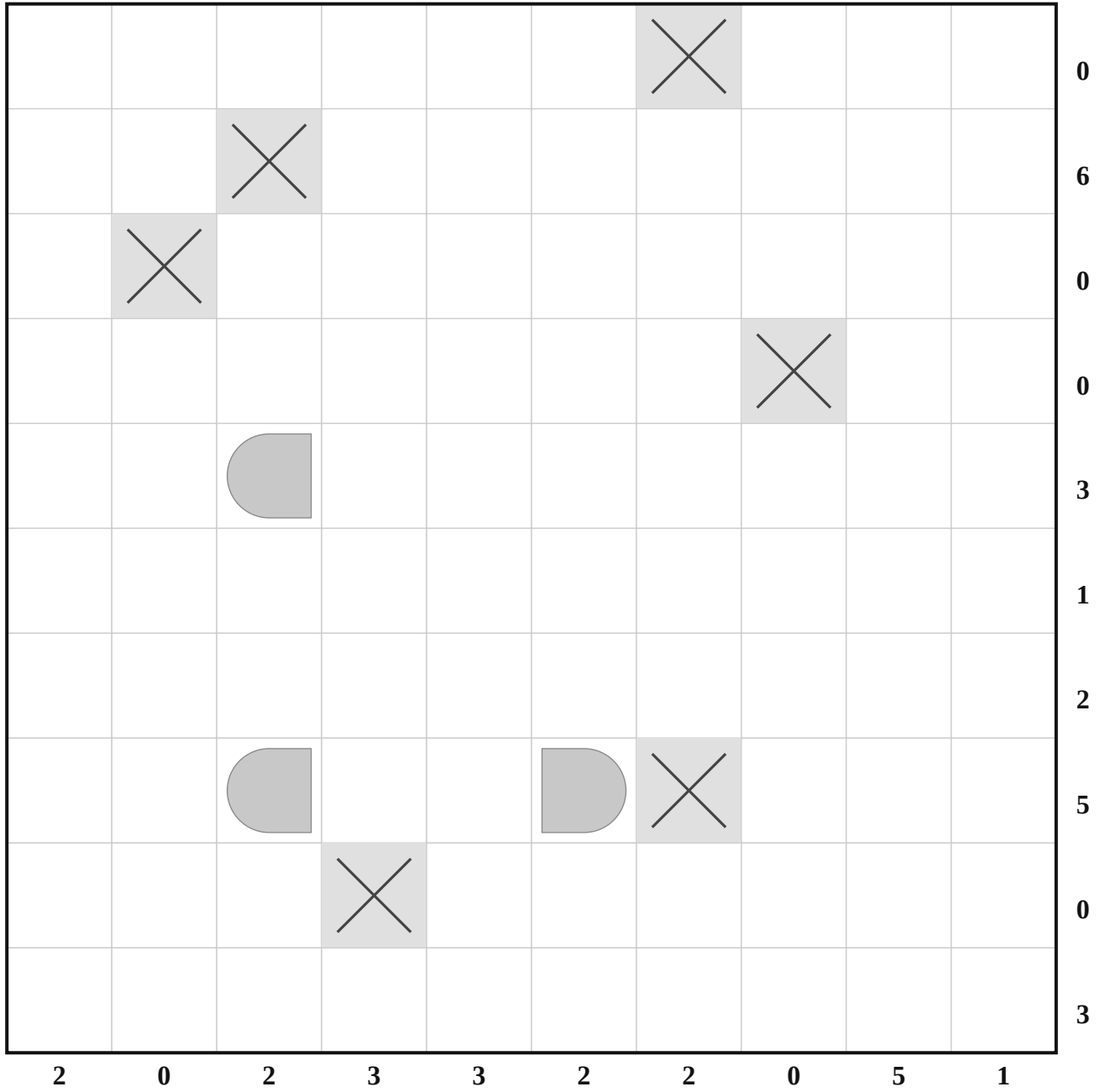

Hints: = Ship segment = Water

FLEET

- Battleship
- Cruiser
- Destroyer
- Submarine

Connect every island with horizontal or vertical bridges — no diagonals. Each number tells you exactly how many bridges meet that island. Bridges cannot cross each other. Up to two bridges can run between any two islands.

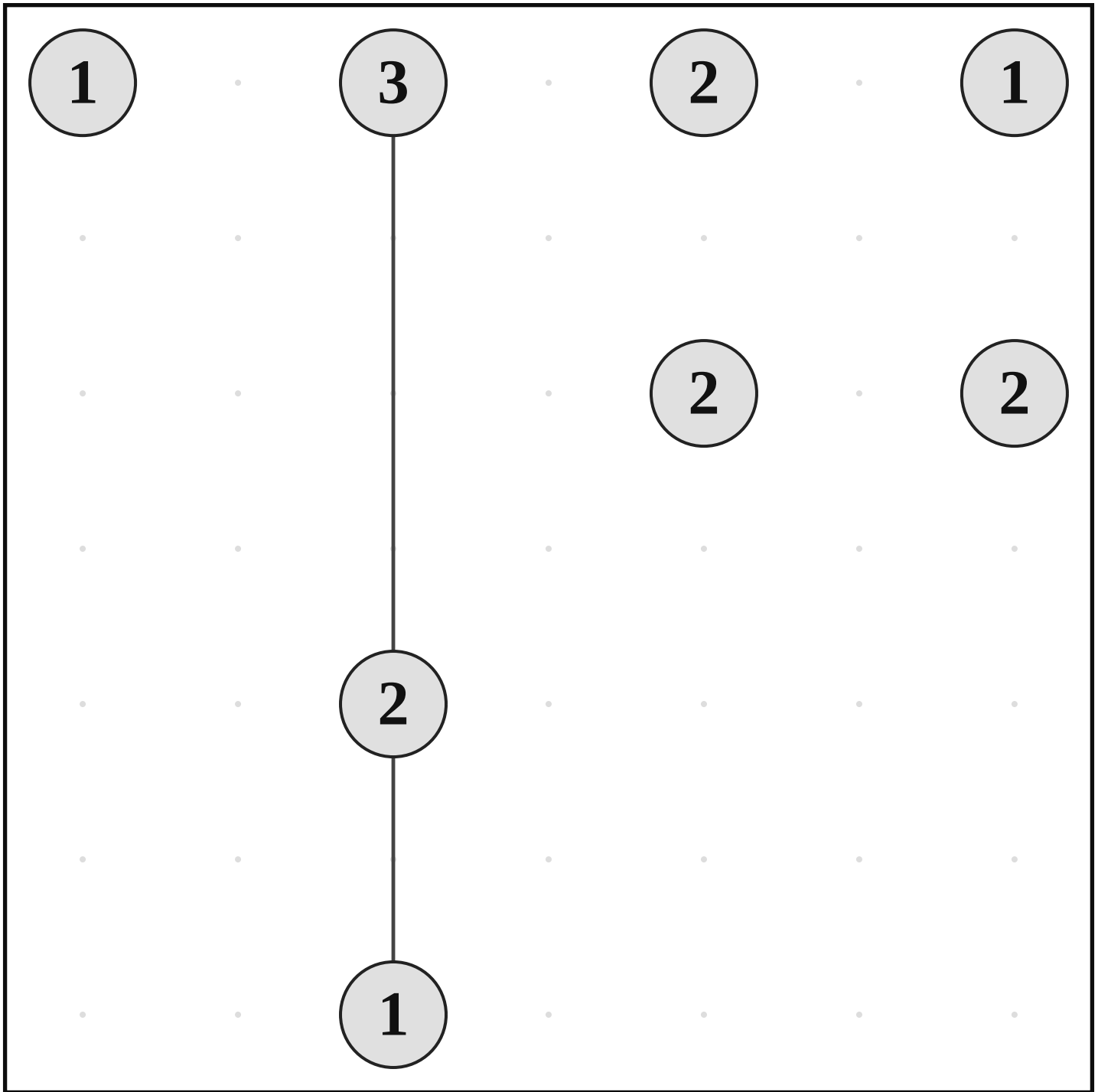

2 bridges shown as hints.

Fill each cell with 0 or 1. Every row and column must contain exactly ten 0s and ten 1s.

Never place 3 of the same digit in a row, whether in a row or column. No two rows or columns can be the same.

	1	1	0	0	1					0	1		1	1	0	0	1	1		
	0	0		0	1	1			0	0	1			1	0	1	0	0		
0	1	1			0	0	1	0	1	1	0				1	1	0	1	0	
	0	0		1		0	1	0	1		1	1	0			0	1	1	0	
		1	0	0	1	1	0	1	0		0	0		0	1	1	0	0	1	
1			0	0	1		0	1	0	1	0		0	0	1			0	1	
1	0	0	1	1	0	0		0	1	0		0	1	1	0	1	0	1	0	
0	1		0		1	1	0	0	1	0	1			1		1		1	0	
0	1		1	1		1	0	1	0				0	0	1			0	1	
1	0		0	0			1	1		0		0	1		1	1	0	0	1	
1	0	0	1	1		1	0	0	1	1	0	0	1		0	0	1	1		
		1	0	0	1	1	0	1	0		0	1	0	0	1	0	1			
	0	0	1		0	0	1	1	0	0	1			0	1	1				
0		1	0	0	1	0	1		1	0		1		1	0		1	0	1	
0	1			0	1	1					0	0	1	0		0	1	0	1	
1	0		0	1	0	0	1	0			1	1	0		0				0	
1	0	0	1	1	0		0	1		1	0	1	0					0	1	
0	1	0	1								1	0	0	1	1	0		0	0	1
0	1	1			0						0	1	1	0	1	0	0	1		0
	0	0	1	1	0	0	1		1	1		1	0	0	1			1	0	

Fill every row and column with each number exactly once — no repeats in any row or column.

Puzzle 1

	1		2		3
2	6			5	4
3		6	4	1	2
			6	2	
6	2		5	3	1
5	3	2			

Puzzle 2

4	1		2	3	6
2				6	5
6	3	2	5		4
					3
	2	4		5	1
	6		1	4	2

Puzzle 3

	6	4	5	3	
3	2		1		6
		3			5
1	5	2	3		
	3	1	6	5	2
	4	6	2		

Puzzle 4

2		1		6	3
4	3	6			
6		5			2
3	1		5	2	6
			6	5	4
	6	2	3		1

MAPPING THE UNIVERSE

Rearrange the letters to find the hidden word. Use the hint if you need a little help.

SCRAMBLED	HINT	ANSWER
1. RBTOI	<i>The curved path one object follows around another in space</i>	_____
2. RUALN	<i>Relating to the Moon</i>	_____
3. ROASL	<i>Relating to the Sun</i>	_____
4. ERAFL	<i>A sudden burst of energy released from the surface of the Sun</i>	_____
5. CTREAR	<i>A bowl-shaped hollow on the surface of the Moon</i>	_____
6. ECTOKR	<i>A vehicle powered by burning fuel to escape Earth's gravity</i>	_____
7. EMORTE	<i>A streak of light caused by space rock burning in our atmosphere</i>	_____
8. UCVUMA	<i>A space containing no matter — like outer space itself</i>	_____
9. SUAECLP	<i>A small sealed compartment in which astronauts travel</i>	_____
10. ERAODTIS	<i>A rocky object orbiting the sun smaller than a planet</i>	_____
11. ESIETLLTA	<i>An object that orbits a planet — natural or man-made</i>	_____
12. EBLKALOHC	<i>A region of space where gravity is so strong nothing escapes</i>	_____
13. UNAAHCPDL	<i>The platform from which a rocket lifts off</i>	_____

DOTS & BOXES — A TWO-PLAYER GAME

Player 1: X Player 2: O

*Take turns drawing one line between two neighbouring dots (H or V).
Complete the 4th side of a box → write your initial inside and take another turn. Most boxes wins.*

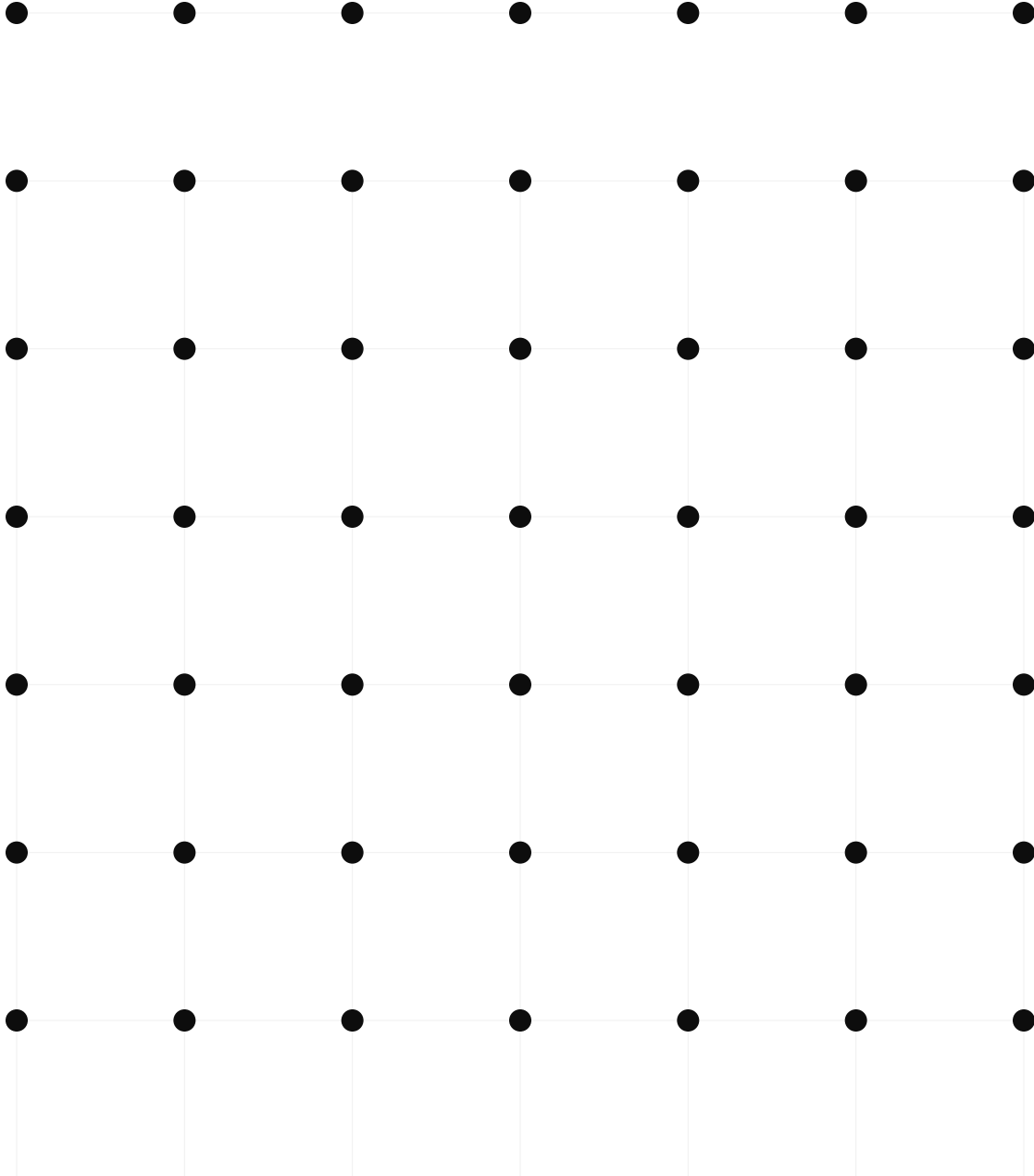

X BOXES _____	O BOXES _____
-------------------------	-------------------------

SUNRISE GARDENS VILLAGE

Answer Key · Thursday, April 16, 2026

ANSWERS — DAILY QUIZ · SPACE & EXPLORATION

1. How long does light from the Sun take to reach Earth?

- A) About 2 minutes
- B) About 8 minutes ✓**
- C) About 20 minutes
- D) About 1 hour

2. Which planet has the most moons in our solar system?

- A) Jupiter
- B) Saturn ✓**
- C) Uranus
- D) Neptune

3. Who was the first human being to travel in space?

- A) Buzz Aldrin
- B) Alan Shepard
- C) Yuri Gagarin ✓**
- D) John Glenn

SUNRISE GARDENS VILLAGE

Answer Key · Thursday, April 16, 2026

ANSWERS — SUDOKU

Easy

Easy

1	9	4	3	5	2	7	6	8
5	8	7	6	9	4	3	1	2
6	3	2	8	1	7	5	9	4
9	5	3	1	7	8	4	2	6
7	4	8	9	2	6	1	3	5
2	6	1	5	4	3	8	7	9
8	1	9	2	3	5	6	4	7
3	7	6	4	8	9	2	5	1
4	2	5	7	6	1	9	8	3

9	5	6	7	4	1	3	2	8
3	7	4	5	2	8	9	1	6
8	1	2	6	9	3	7	4	5
4	6	8	9	1	7	5	3	2
1	2	7	8	3	5	4	6	9
5	3	9	2	6	4	8	7	1
6	4	1	3	8	9	2	5	7
2	9	5	4	7	6	1	8	3
7	8	3	1	5	2	6	9	4

SUNRISE GARDENS VILLAGE

Answer Key · Thursday, April 16, 2026

ANSWERS — WORD SEARCH — MAPPING THE UNIVERSE

A	I	E	Y	N	C	T	X	E	H	N	R	P	E	Y
J	V	Q	M	O	S	F	E	O	Z	O	N	X	U	O
L	A	U	S	P	J	Y	G	L	N	C	O	M	E	T
R	R	M	W	P	N	M	U	Y	E	I	T	Z	H	I
S	O	W	O	R	B	I	T	A	L	S	U	A	E	N
S	O	K	G	R	A	S	L	U	P	Y	C	Q	P	V
P	D	I	E	C	L	I	P	S	E	O	W	O	E	M
N	O	R	T	U	E	N	R	X	H	O	K	U	P	R
T	O	V	N	M	M	C	H	O	R	I	Z	O	N	E
O	R	T	L	A	L	U	B	E	N	S	L	U	M	G
R	J	O	J	C	N	X	N	R	U	T	A	S	C	H
K	P	F	T	Y	T	I	V	A	R	G	F	L	E	O
P	J	J	Y	Y	H	G	A	L	A	X	Y	N	E	L
I	H	E	C	I	T	S	L	O	S	M	M	X	N	J
D	E	P	A	D	C	R	W	H	T	I	N	E	Z	D

■ = word letter (grey = filler)

SUNRISE GARDENS VILLAGE

Answer Key · Thursday, April 16, 2026

ANSWERS — HITORI

Puzzle 1 — Solution

3		1	4
	4	3	1
4	1		3
1	3	4	

Puzzle 2 — Solution

4	3	1	
3		4	1
2	1		4
	4	2	3

Puzzle 3 — Solution

2		1	4
3	1		2
	4	2	3
4	2	3	

Puzzle 4 — Solution

2		4	3
1	2		4
3	4	2	
	3	1	2

SUNRISE GARDENS VILLAGE

Answer Key · Thursday, April 16, 2026

ANSWERS — CRYPTOGRAM

ON EXPLORATION

The Earth Is The Cradle Of Humanity But One Cannot Live In A Cradle Forever

— Konstantin Tsiolkovsky

ON WONDER

Somewhere Something Incredible Is Waiting To Be Known

— Carl Sagan

ON THE MOON

That Is One Small Step For Man One Giant Leap For Mankind

— Neil Armstrong

SUNRISE GARDENS VILLAGE

Answer Key · Thursday, April 16, 2026

ANSWERS — NUMBER PYRAMID

Pyramid 1 — Solution

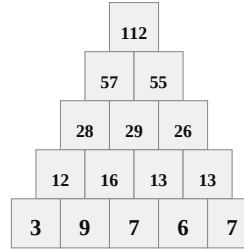

Pyramid 2 — Solution

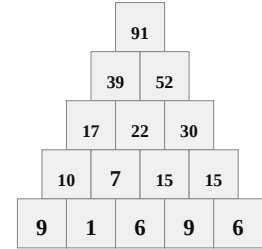

Pyramid 3 — Solution

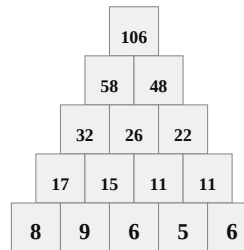

Pyramid 4 — Solution

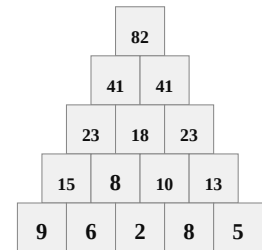

SUNRISE GARDENS VILLAGE

Answer Key · Thursday, April 16, 2026

ANSWERS — NAVAL BATTLE

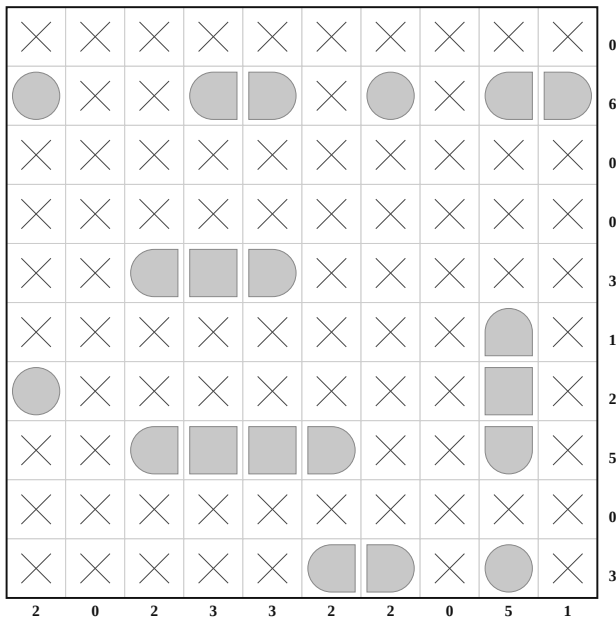

FLEET



SUNRISE GARDENS VILLAGE

Answer Key · Thursday, April 16, 2026

ANSWERS — BRIDGES

Note: This puzzle may have more than one valid solution. Any arrangement satisfying all island counts with all islands connected is correct.

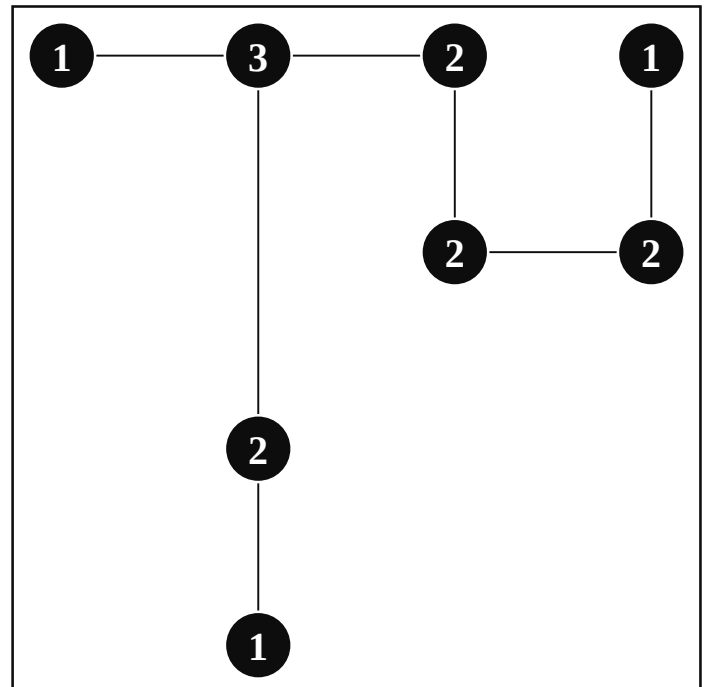

SUNRISE GARDENS VILLAGE

Answer Key · Thursday, April 16, 2026

ANSWERS — BINERO

0	1	1	0	0	1	0	1	0	1	0	1	0	1	1	0	0	1	1	0
1	0	0	1	0	1	1	0	1	0	0	1	1	0	1	0	1	0	0	1
0	1	1	0	1	0	0	1	0	1	1	0	0	1	0	1	1	0	1	0
1	0	0	1	1	0	0	1	0	1	0	1	1	0	1	0	0	1	1	0
0	1	1	0	0	1	1	0	1	0	1	0	0	1	0	1	1	0	0	1
1	0	1	0	0	1	1	0	1	0	1	0	1	0	0	1	0	1	0	1
1	0	0	1	1	0	0	1	0	1	0	1	0	1	1	0	1	0	1	0
0	1	1	0	0	1	1	0	0	1	0	1	0	1	1	0	1	0	1	0
0	1	0	1	1	0	1	0	1	0	1	0	0	1	0	1	0	1	0	1
1	0	1	0	0	1	0	1	1	0	0	1	0	1	0	1	1	0	0	1
1	0	0	1	1	0	1	0	0	1	1	0	0	1	1	0	0	1	1	0
0	1	1	0	0	1	1	0	1	0	1	0	0	1	0	1	0	1	0	1
1	0	0	1	1	0	0	1	1	0	0	1	0	1	0	1	1	0	1	0
0	1	1	0	0	1	1	0	1	0	1	0	0	1	0	1	0	1	0	1
1	0	1	0	1	1	0	1	0	1	0	1	1	0	1	0	0	1	0	1
1	0	1	0	1	0	0	1	0	1	1	0	1	0	1	0	1	0	1	0
1	0	0	1	1	0	1	0	0	1	1	0	0	1	1	0	0	1	1	0
0	1	0	1	0	1	0	1	0	1	1	0	0	1	1	0	1	0	0	1
0	1	1	0	1	0	1	0	1	0	0	1	1	0	1	0	0	1	1	0
1	0	0	1	1	0	0	1	0	1	1	0	0	1	1	0	1	0	1	0

SUNRISE GARDENS VILLAGE

Answer Key · Thursday, April 16, 2026

ANSWERS — LATIN SQUARE

Puzzle 1 — Solution

4	1	5	2	6	3
2	6	1	3	5	4
3	5	6	4	1	2
1	4	3	6	2	5
6	2	4	5	3	1
5	3	2	1	4	6

Puzzle 2 — Solution

4	1	5	2	3	6
2	4	1	3	6	5
6	3	2	5	1	4
1	5	6	4	2	3
3	2	4	6	5	1
5	6	3	1	4	2

Puzzle 3 — Solution

2	6	4	5	3	1
3	2	5	1	4	6
6	1	3	4	2	5
1	5	2	3	6	4
4	3	1	6	5	2
5	4	6	2	1	3

Puzzle 4 — Solution

2	5	1	4	6	3
4	3	6	2	1	5
6	4	5	1	3	2
3	1	4	5	2	6
1	2	3	6	5	4
5	6	2	3	4	1

SUNRISE GARDENS VILLAGE

Answer Key · Thursday, April 16, 2026

ANSWERS — WORD SCRAMBLE

SCRAMBLED	ANSWER
1. RBTOI	ORBIT
2. RUALN	LUNAR
3. ROASL	SOLAR
4. ERAFL	FLARE
5. CTREAR	CRATER
6. ECTOKR	ROCKET
7. EMORTE	METEOR
8. UCVUMA	VACUUM
9. SUAELCP	CAPSULE
10. ERAODTIS	ASTEROID
11. ESITLLTA	SATELLITE
12. EBLKALOHC	BLACKHOLE
13. UNAAHCPDL	LAUNCHPAD

DIFFICULTY PACK

Challenger

For: All puzzles at the most difficult level

All Hard

Largest grids, no hints, hardest settings. For your sharpest community members who finish everything before breakfast.

SUNRISE GARDENS VILLAGE

DAILY PUZZLE EDITION

Thursday, April 16, 2026

3-DAY FORECAST · TAMPA

THU	FRI	SAT
84°F	87°F	86°F
Sunny	Sunny	Partly Cloudy

LATEST SCORES

Baseball · MLB	
Tampa Bay Rays 8 vs Chicago White Sox 3	
Baseball · MLB	
Atlanta Braves 6 vs Miami Marlins 3	

DID YOU KNOW

A day on Venus is longer than a year on Venus. It rotates so slowly that it completes an orbit of the Sun before rotating once.

THE STORY BEHIND

The Post-it Note.

In 1968, a 3M scientist named Spencer Silver invented a glue just sticky enough to hold paper without leaving a mark. Nobody knew what to do with it for six years. Then a colleague used it to mark pages in his hymnal. Within a decade, every office in the world had them.

DAILY QUIZ · SPACE & EXPLORATION

- How long does light from the Sun take to reach Earth?
 - A) About 2 minutes
 - B) About 8 minutes
 - C) About 20 minutes
 - D) About 1 hour
- Which planet has the most moons in our solar system?
 - A) Jupiter
 - B) Saturn
 - C) Uranus
 - D) Neptune
- Who was the first human being to travel in space?
 - A) Buzz Aldrin
 - B) Alan Shepard
 - C) Yuri Gagarin
 - D) John Glenn

SUDOKU

Fill each row, column & 3×3 box with 1–9.

Puzzle 1 — Hard

1			3	5		7		8
					4	3		2
6		2	8	1				9
	5	3		7	8			
	4	8		2		1	3	
			5	4		8	7	
	1			3	5	6		7
3		6	4					
4		5		6	1			3

Puzzle 2 — Hard

9		6		4		3	2	
	7	4		2	8			6
8	1						4	
	6			1		5	3	
1			8		5			9
	3	9		6			7	
	4						5	7
2			4	7		1	8	
	8	3		5		6		4

MAPPING THE UNIVERSE

Search for words horizontally, vertically, and diagonally — including backwards.

**COMET
GRAVITY
PULSAR**

**COSMOS
HORIZON
SATURN**

**ECLIPSE
NEBULA
SOLSTICE**

**EQUINOX
NEUTRON
TELESCOPE**

**GALAXY
ORBITAL
ZENITH**

C	H	K	Y	T	I	V	A	R	G	P	F	T	F	L
E	O	P	E	J	J	Y	Y	H	N	E	L	I	H	M
M	X	N	J	C	D	E	P	H	A	D	C	R	W	D
S	K	K	O	E	L	U	T	M	A	T	H	F	R	X
T	N	W	S	P	E	I	V	O	E	I	R	U	X	Q
L	E	J	E	O	N	C	P	L	U	K	X	G	N	D
Z	U	Y	K	E	L	L	E	S	S	F	C	A	E	B
E	T	J	Z	Y	J	S	A	Q	E	E	O	L	B	N
Q	R	D	L	C	C	Z	T	T	X	L	M	A	U	O
U	O	K	P	O	S	P	H	I	I	K	E	X	L	Z
I	N	J	P	A	R	Z	U	A	C	B	T	Y	A	I
N	N	E	T	K	W	N	R	L	G	E	R	O	N	R
O	L	U	X	E	H	R	M	V	S	F	V	O	C	O
X	R	C	O	S	M	O	S	C	P	A	C	O	L	H
N	G	G	Z	O	E	E	G	N	P	V	R	Z	P	K

Shade cells so no number appears twice in any row or column. Shaded cells may not touch horizontally or vertically, but can touch diagonally. All unshaded cells must stay connected.

Puzzle 1

4	6	5	2	7	3	2	1
2	3	6	4	5	8	3	7
5	4	8	7	7	1	6	2
1	3	2	6	4	5	7	3
1	8	3	1	2	6	5	4
6	2	8	5	8	7	1	3
8	5	7	3	1	2	8	6
3	7	1	2	6	8	8	5

Puzzle 2

5	4	3	2	6	7	1	2
1	1	2	3	5	8	4	7
2	6	5	6	3	4	7	1
3	7	6	5	2	3	8	4
8	6	4	1	7	2	8	3
1	3	5	7	4	6	2	5
4	2	7	8	5	5	3	6
7	5	1	3	8	3	6	2

Puzzle 3

2	6	3	2	8	7	5	4
2	4	5	6	1	6	8	7
5	4	4	8	3	6	7	2
8	2	7	1	4	4	3	6
4	3	1	2	6	8	2	5
6	7	8	4	2	5	6	3
3	8	6	5	7	2	4	5
7	5	3	3	4	1	6	8

Puzzle 4

7	6	5	8	4	1	5	2
8	1	1	2	3	7	5	6
7	3	7	6	5	8	1	4
6	5	8	4	1	2	7	8
5	8	4	7	2	3	6	7
3	7	6	5	4	4	2	1
1	2	5	7	6	5	4	8
4	1	2	3	7	1	8	5

All three puzzles share the same key. Decode each letter using the cipher below.

CIPHER KEY — encoded letter = plain letter

A=I	B=H	C=A	D=V	E=K	F=U	G=W	H=Q	I=Z	J=T	K=S	L=N	M=J
N=G	O=B	P=L	Q=P	R=E	S=X	T=M	U=R	V=O	W=C	X=D	Y=F	Z=Y

ON EXPLORATION

J B R R C U J B A K J B R W U C X P R V Y

B F T C L A J Z O F J V L R W C L L V J

P A D R A L C W U C X P R Y V U R D R U

— Konstantin Tsiolkovsky

ON WONDER

K V T R G B R U R K V T R J B A L N

A L W U R X A O P R A K G C A J A L N J V O R

E L V G L

— Carl Sagan

ON THE MOON

J B C J A K V L R K T C P P K J R Q Y V U

T C L V L R N A C L J P R C Q Y V U

T C L E A L X

— Neil Armstrong

Each brick equals the sum of the two bricks directly below it.
 Fill every empty brick. Work upward by adding, or downward by subtracting.

Pyramid 1

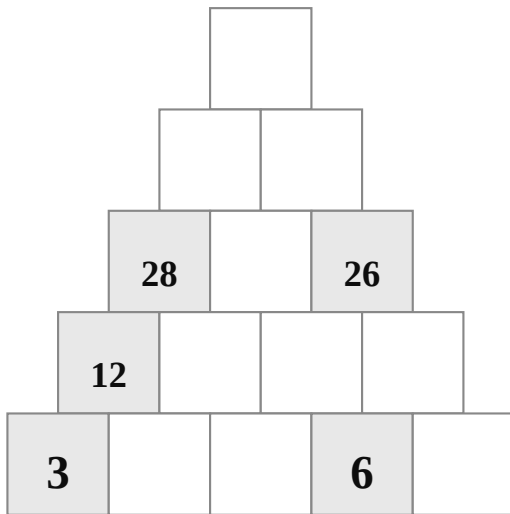

Pyramid 2

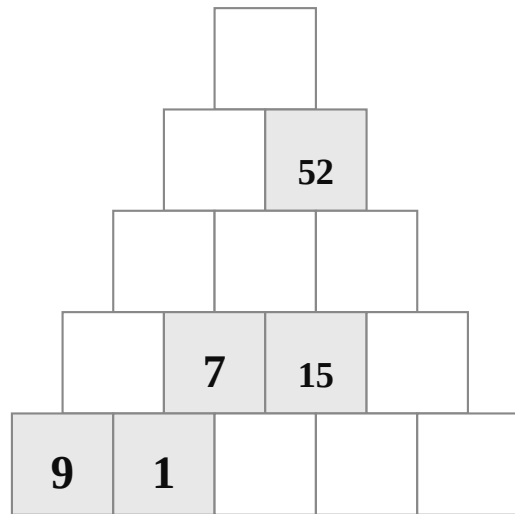

Pyramid 3

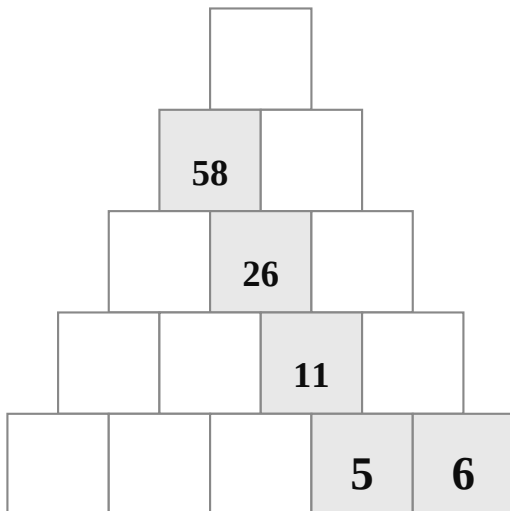

Pyramid 4

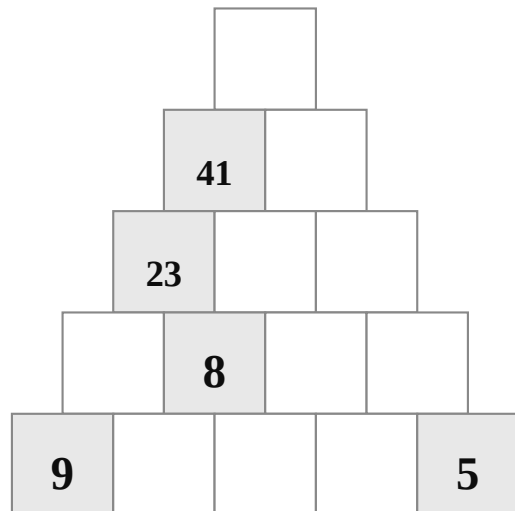

Use the row and column numbers to locate every ship. Ships cannot touch each other, not even diagonally.

Numbers show ship cells per row and column. Mark empty cells to narrow down where ships can fit.

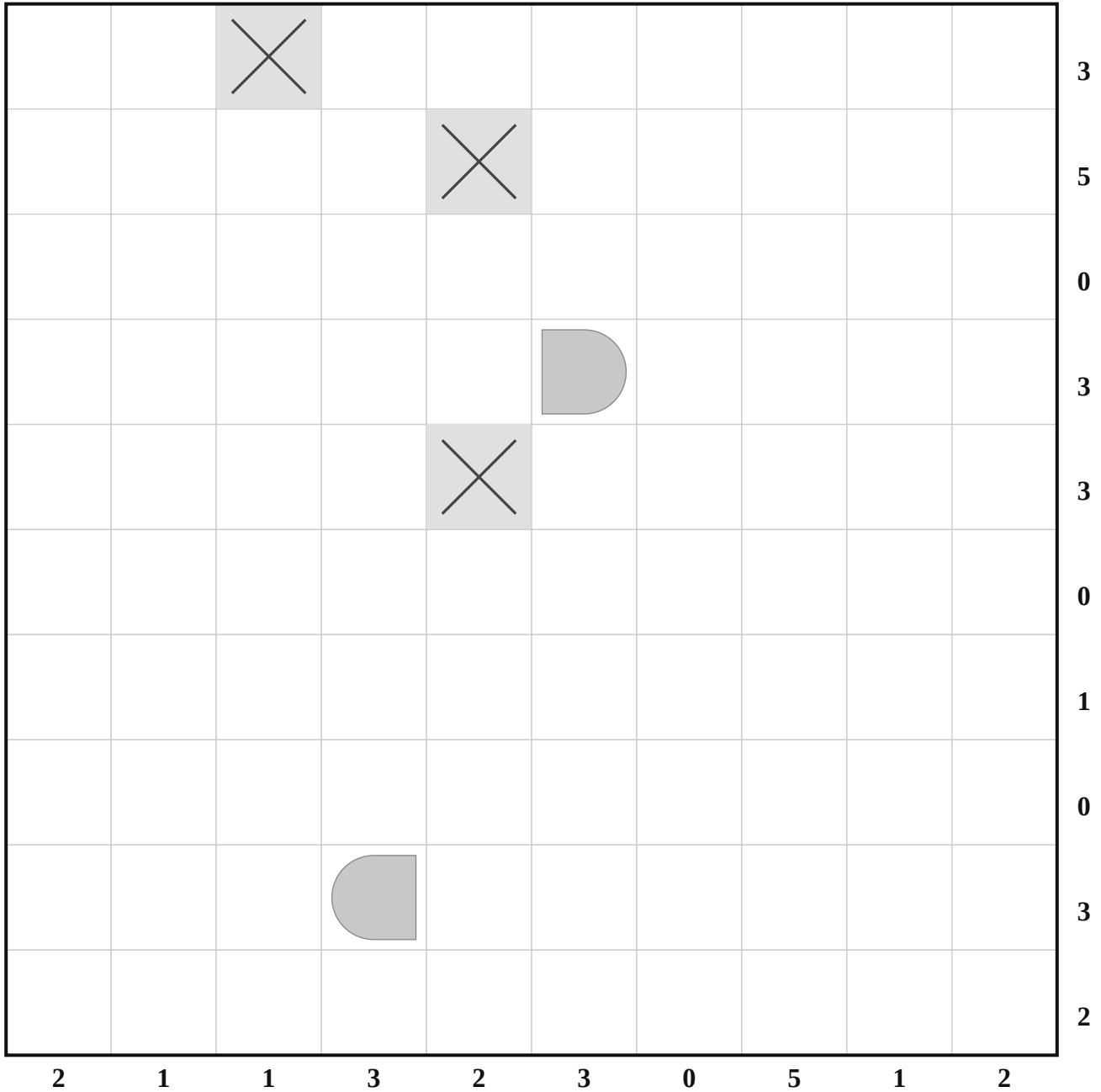

Hints: = Ship segment = Water

FLEET

- Battleship
- Cruiser
- Destroyer
- Submarine

Connect every island with horizontal or vertical bridges — no diagonals. Each number tells you exactly how many bridges meet that island. Bridges cannot cross each other. Up to two bridges can run between any two islands.

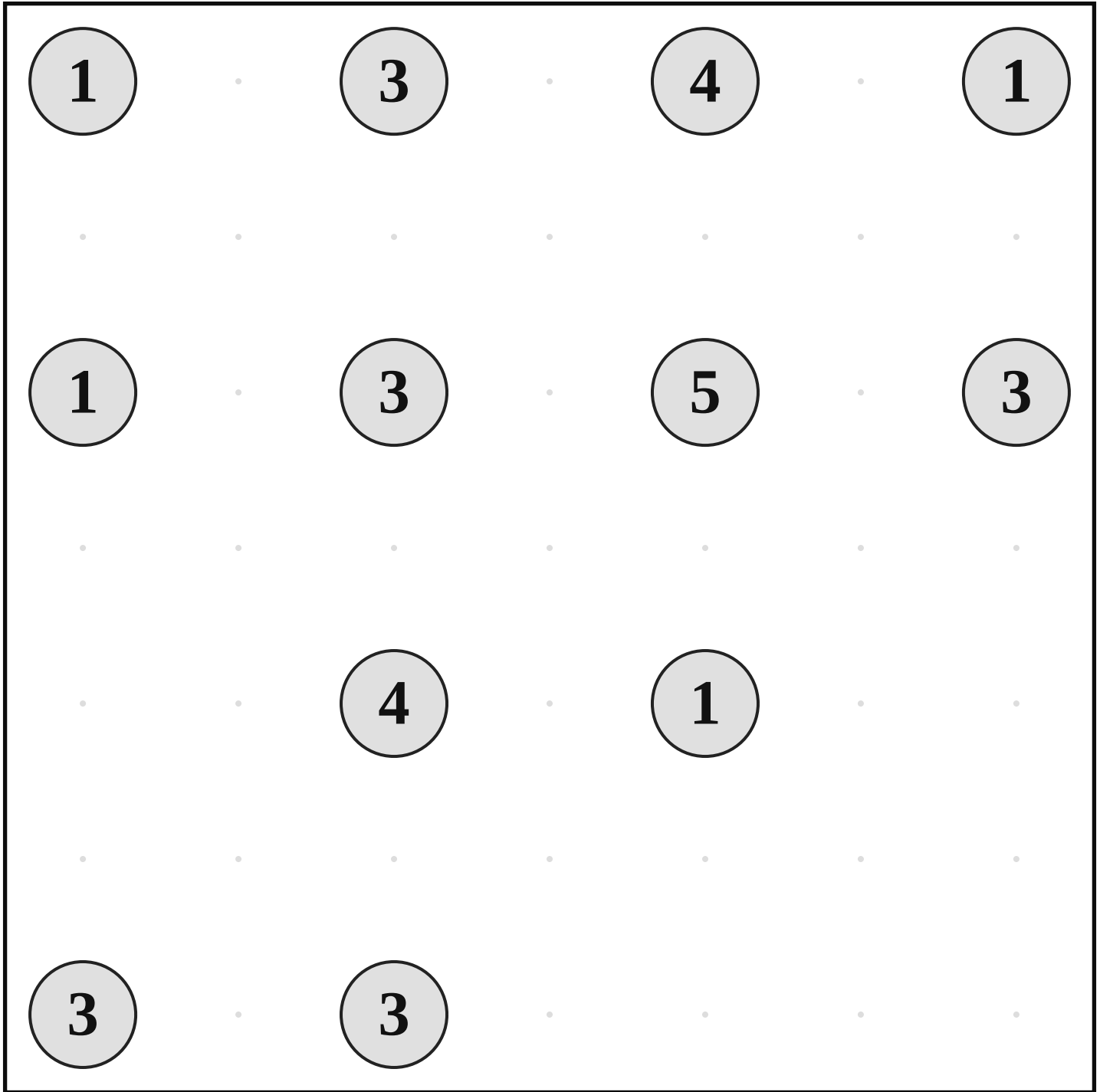

Fill each cell with 0 or 1. Every row and column must contain exactly ten 0s and ten 1s.

Never place 3 of the same digit in a row, whether in a row or column. No two rows or columns can be the same.

				0			1			0	1	0	1		0			1		
	0	0		0	1									1		1	0			
0					0			0	1		0			0				1		
	0	0		1					1		1		0	1		0	1	1		
		1	0	0	1	1	0		0		0	0	1		1				1	
					1				0				0	0	1				0	1
1	0				0	0			1	0		0	1							
0	1								1	0	1			1				1	0	
0	1			1				1					0		1		1	0		
1	0	1	0	0	1	0							1			1			1	
	0			1		1	0	0	1									1		
		1	0			1			0			1		0	1	0	1			
		0				0	1	1		0	1		1		1	1	0	1		
							1	0	1			1		1			1		1	
	1					1						0	1			0		0	1	
1			0		0	0	1	0							0				0	
			1		0		0	1		1			0			0			0	
			1		1		1			1	0	0		1						
0	1	1										1	0	1				1		
				1	1	0	0	1			1		1							

Fill every row and column with each number exactly once — no repeats in any row or column.

Puzzle 1

				3		4	7
			6			2	
				2	4	7	
1					7		5
8		4				5	1
3		7	2				
	6		7		8		
2				5			3

Puzzle 2

	1	5			2	4	3
2							
		2	6			8	
			1	3	6		
1		4	7		8	2	
	7						
4		7		5			
		3		8		5	1

Puzzle 3

			3	2	6		8
	5		4	7			3
	3	7		6			
		2		5			7
					1	7	5
4	7			3		1	
				4		8	2
	6						

Puzzle 4

		7		4	8		
7			4		1	8	
	6						
5	2						
		2	1	3			
		1				4	3
6		5					8
		4	8	1		7	2

MAPPING THE UNIVERSE

Rearrange the letters to find the hidden word. Use the hint if you need a little help.

SCRAMBLED	HINT	ANSWER
1. DLACUAPHN	<i>The platform from which a rocket lifts off</i>	_____
2. LHEKOLBCA	<i>A region of space where gravity is so strong nothing escapes</i>	_____
3. ATELILEST	<i>An object that orbits a planet — natural or man-made</i>	_____
4. TOESIADR	<i>A rocky object orbiting the sun smaller than a planet</i>	_____
5. USCELPA	<i>A small sealed compartment in which astronauts travel</i>	_____
6. CUAVMU	<i>A space containing no matter — like outer space itself</i>	_____
7. EMORTE	<i>A streak of light caused by space rock burning in our atmosphere</i>	_____
8. COETKR	<i>A vehicle powered by burning fuel to escape Earth's gravity</i>	_____
9. ATERRC	<i>A bowl-shaped hollow on the surface of the Moon</i>	_____
10. LAREF	<i>A sudden burst of energy released from the surface of the Sun</i>	_____
11. LOARS	<i>Relating to the Sun</i>	_____
12. NLAUR	<i>Relating to the Moon</i>	_____
13. BRTOI	<i>The curved path one object follows around another in space</i>	_____

DOTS & BOXES — A TWO-PLAYER GAME

Player 1: X Player 2: O

*Take turns drawing one line between two neighbouring dots (H or V).
Complete the 4th side of a box → write your initial inside and take another turn. Most boxes wins.*

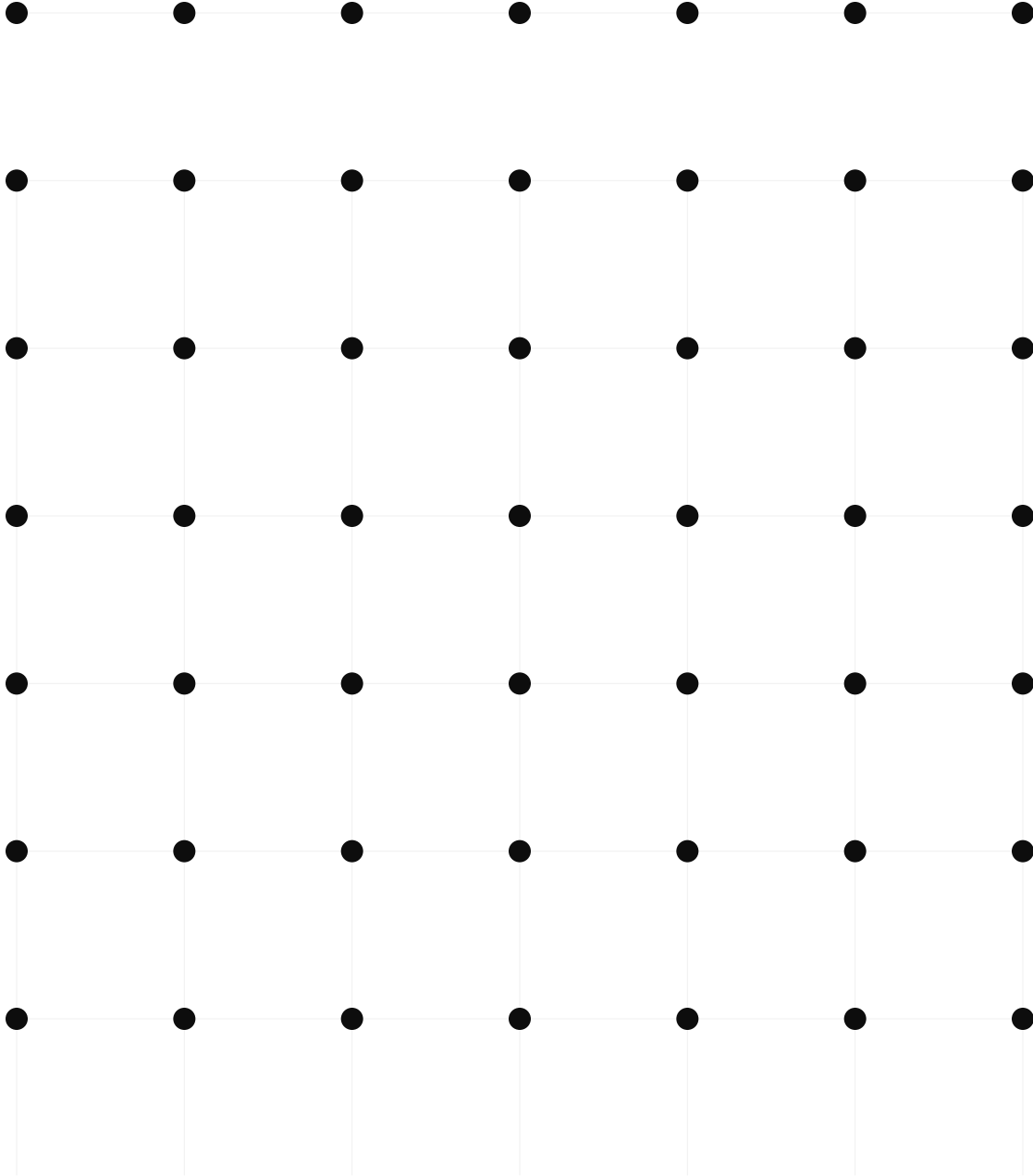

X BOXES _____	O BOXES _____
-------------------------	-------------------------

SUNRISE GARDENS VILLAGE

Answer Key · Thursday, April 16, 2026

ANSWERS — DAILY QUIZ · SPACE & EXPLORATION

1. How long does light from the Sun take to reach Earth?

- A) About 2 minutes
- C) About 20 minutes

B) About 8 minutes ✓
D) About 1 hour

2. Which planet has the most moons in our solar system?

- A) Jupiter
- C) Uranus

B) Saturn ✓
D) Neptune

3. Who was the first human being to travel in space?

- A) Buzz Aldrin

B) Alan Shepard
D) John Glenn

C) Yuri Gagarin ✓

SUNRISE GARDENS VILLAGE

Answer Key · Thursday, April 16, 2026

ANSWERS — SUDOKU

Hard

Hard

1	9	4	3	5	2	7	6	8
5	8	7	6	9	4	3	1	2
6	3	2	8	1	7	5	9	4
9	5	3	1	7	8	4	2	6
7	4	8	9	2	6	1	3	5
2	6	1	5	4	3	8	7	9
8	1	9	2	3	5	6	4	7
3	7	6	4	8	9	2	5	1
4	2	5	7	6	1	9	8	3

9	5	6	7	4	1	3	2	8
3	7	4	5	2	8	9	1	6
8	1	2	6	9	3	7	4	5
4	6	8	9	1	7	5	3	2
1	2	7	8	3	5	4	6	9
5	3	9	2	6	4	8	7	1
6	4	1	3	8	9	2	5	7
2	9	5	4	7	6	1	8	3
7	8	3	1	5	2	6	9	4

SUNRISE GARDENS VILLAGE

Answer Key · Thursday, April 16, 2026

ANSWERS — WORD SEARCH — MAPPING THE UNIVERSE

A	I	E	Y	N	C	T	X	E	H	N	R	P	E	Y
J	V	Q	M	O	S	F	E	O	Z	O	N	X	U	O
L	A	U	S	P	J	Y	G	L	N	C	O	M	E	T
R	R	M	W	P	N	M	U	Y	E	I	T	Z	H	I
S	O	W	O	R	B	I	T	A	L	S	U	A	E	N
S	O	K	G	R	A	S	L	U	P	Y	C	Q	P	V
P	D	I	E	C	L	I	P	S	E	O	W	O	E	M
N	O	R	T	U	E	N	R	X	H	O	K	U	P	R
T	O	V	N	M	M	C	H	O	R	I	Z	O	N	E
O	R	T	L	A	L	U	B	E	N	S	L	U	M	G
R	J	O	J	C	N	X	N	R	U	T	A	S	C	H
K	P	F	T	Y	T	I	V	A	R	G	F	L	E	O
P	J	J	Y	Y	H	G	A	L	A	X	Y	N	E	L
I	H	E	C	I	T	S	L	O	S	M	M	X	N	J
D	E	P	A	D	C	R	W	H	T	I	N	E	Z	D

■ = word letter (grey = filler)

SUNRISE GARDENS VILLAGE

Answer Key · Thursday, April 16, 2026

ANSWERS — HITORI

Puzzle 1 — Solution

4	6	5		7	3	2	1
2		6	4	5	8	3	7
5	4	8	7		1	6	2
1	3	2	6	4	5	7	
	8	3	1	2	6	5	4
6	2		5	8	7	1	3
8	5	7	3	1	2		6
3	7	1	2	6		8	5

Puzzle 2 — Solution

5	4	3	2	6	7	1	
	1	2	3	5	8	4	7
2		5	6	3	4	7	1
3	7	6	5	2		8	4
8	6	4	1	7	2		3
1	3		7	4	6	2	5
4	2	7	8		5	3	6
7	5	1		8	3	6	2

Puzzle 3 — Solution

	6	3	2	8	7	5	4
2	4	5	6	1		8	7
5		4	8	3	6	7	2
8	2	7	1		4	3	6
4	3	1		6	8	2	5
6	7	8	4	2	5		3
3	8	6	5	7	2	4	
7	5		3	4	1	6	8

Puzzle 4 — Solution

7	6	5	8	4	1		2
8		1	2	3	7	5	6
	3	7	6	5	8	1	4
6	5	8	4	1	2	7	
5	8	4		2	3	6	7
3	7	6	5		4	2	1
1	2		7	6	5	4	8
4	1	2	3	7		8	5

SUNRISE GARDENS VILLAGE

Answer Key · Thursday, April 16, 2026

ANSWERS — CRYPTOGRAM

ON EXPLORATION

The Earth Is The Cradle Of Humanity But One Cannot Live In A Cradle Forever

— Konstantin Tsiolkovsky

ON WONDER

Somewhere Something Incredible Is Waiting To Be Known

— Carl Sagan

ON THE MOON

That Is One Small Step For Man One Giant Leap For Mankind

— Neil Armstrong

SUNRISE GARDENS VILLAGE

Answer Key · Thursday, April 16, 2026

ANSWERS — NAVAL BATTLE

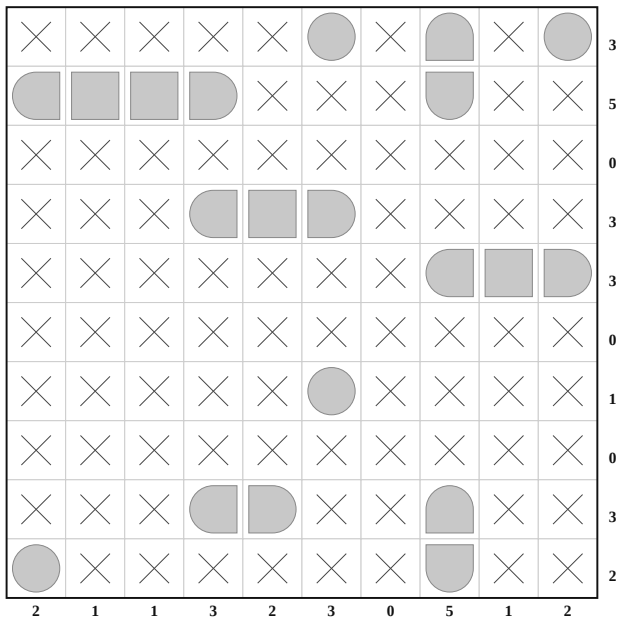

FLEET



SUNRISE GARDENS VILLAGE

Answer Key · Thursday, April 16, 2026

ANSWERS — NUMBER PYRAMID

Pyramid 1 — Solution

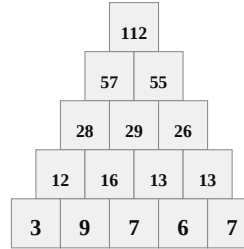

Pyramid 2 — Solution

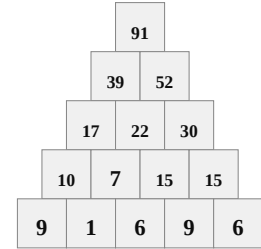

Pyramid 3 — Solution

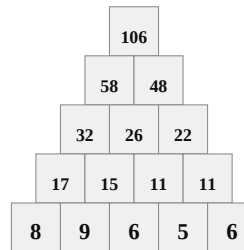

Pyramid 4 — Solution

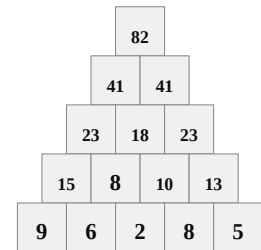

SUNRISE GARDENS VILLAGE

Answer Key · Thursday, April 16, 2026

ANSWERS — BRIDGES

Note: This puzzle may have more than one valid solution. Any arrangement satisfying all island counts with all islands connected is correct.

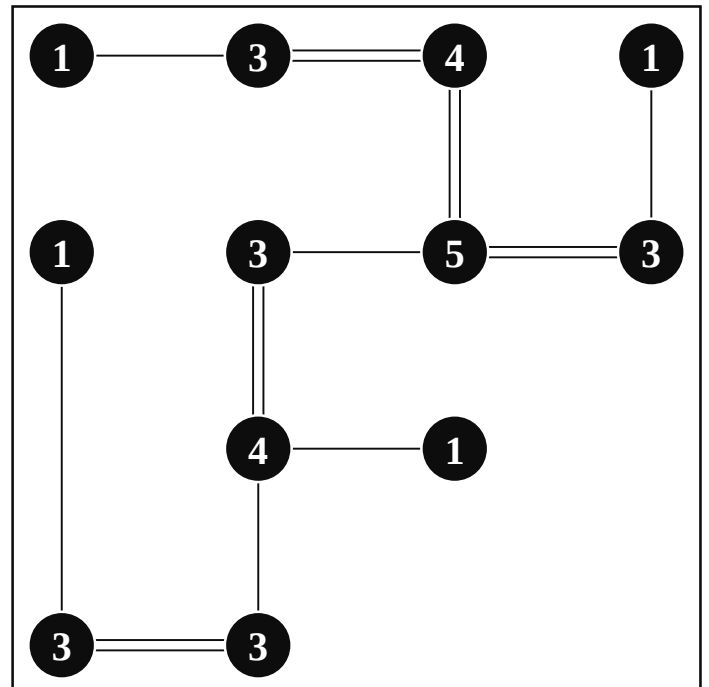

SUNRISE GARDENS VILLAGE

Answer Key · Thursday, April 16, 2026

ANSWERS — BINERO

0	1	1	0	0	1	0	1	0	1	0	1	0	1	1	0	0	1	1	0
1	0	0	1	0	1	1	0	1	0	0	1	1	0	1	0	1	0	0	1
0	1	1	0	1	0	0	1	0	1	1	0	0	1	0	1	1	0	1	0
1	0	0	1	1	0	0	1	0	1	0	1	1	0	1	0	0	1	1	0
0	1	1	0	0	1	1	0	1	0	1	0	0	1	0	1	1	0	0	1
1	0	1	0	0	1	1	0	1	0	1	0	1	0	0	1	0	1	0	1
1	0	0	1	1	0	0	1	0	1	0	1	0	1	1	0	1	0	1	0
0	1	1	0	0	1	1	0	0	1	0	1	0	1	1	0	1	0	1	0
0	1	0	1	1	0	1	0	1	0	1	0	1	0	0	1	0	1	0	1
1	0	1	0	0	1	0	1	1	0	0	1	0	1	0	1	1	0	0	1
1	0	0	1	1	0	1	0	0	1	1	0	0	1	1	0	0	1	1	0
0	1	1	0	0	1	1	0	1	0	1	0	1	0	0	1	0	1	0	1
1	0	0	1	1	0	0	1	1	0	0	1	0	1	0	1	1	0	1	0
0	1	1	0	0	1	1	0	1	0	1	0	1	0	0	1	0	1	0	1
0	1	0	1	0	1	1	0	1	0	1	0	0	1	0	1	0	1	0	1
1	0	1	0	1	0	0	1	0	1	1	0	1	0	1	0	1	0	1	0
1	0	0	1	1	0	1	0	0	1	1	0	0	1	1	0	0	1	1	0
0	1	1	0	0	1	1	0	1	0	1	0	1	0	0	1	0	1	0	1
1	0	0	1	1	0	0	1	1	0	0	1	0	1	0	1	1	0	1	0
0	1	1	0	0	1	1	0	1	0	1	0	0	1	0	1	0	0	1	0
0	1	1	0	1	0	1	0	1	0	0	1	1	0	1	0	0	1	1	0
1	0	0	1	1	0	0	1	0	1	1	0	1	0	0	1	1	0	1	0

SUNRISE GARDENS VILLAGE

Answer Key · Thursday, April 16, 2026

ANSWERS — LATIN SQUARE

Puzzle 1 — Solution

6	1	8	5	3	2	4	7
7	5	1	6	8	3	2	4
5	8	3	1	2	4	7	6
1	3	2	8	4	7	6	5
8	2	4	3	7	6	5	1
3	4	7	2	6	5	1	8
4	6	5	7	1	8	3	2
2	7	6	4	5	1	8	3

Puzzle 2 — Solution

6	1	5	8	7	2	4	3
2	8	6	5	4	3	1	7
3	5	2	6	1	7	8	4
5	4	8	1	3	6	7	2
1	3	4	7	6	8	2	5
8	7	1	4	2	5	3	6
4	2	7	3	5	1	6	8
7	6	3	2	8	4	5	1

Puzzle 3 — Solution

7	4	1	3	2	6	5	8
1	5	8	4	7	2	6	3
2	3	7	8	6	5	4	1
6	8	2	1	5	4	3	7
3	2	4	6	8	1	7	5
4	7	5	2	3	8	1	6
5	1	6	7	4	3	8	2
8	6	3	5	1	7	2	4

Puzzle 4 — Solution

2	1	7	3	4	8	5	6
7	3	6	4	2	1	8	5
1	6	3	5	8	7	2	4
5	2	8	7	6	4	3	1
4	8	2	1	3	5	6	7
8	7	1	6	5	2	4	3
6	4	5	2	7	3	1	8
3	5	4	8	1	6	7	2

SUNRISE GARDENS VILLAGE

Answer Key · Thursday, April 16, 2026

ANSWERS — WORD SCRAMBLE

SCRAMBLED	ANSWER
1. DLACUAPHN	LAUNCHPAD
2. LHEKOLBCA	BLACKHOLE
3. ATELILEST	SATELLITE
4. TOESIADR	ASTEROID
5. USCELPA	CAPSULE
6. CUAVMU	VACUUM
7. EMORTE	METEOR
8. COETKR	ROCKET
9. ATERRC	CRATER
10. LAREF	FLARE
11. LOARS	SOLAR
12. NLUR	LUNAR
13. BRTOI	ORBIT